



Catálogo
general de
productos

Presentación



Humeco, desde su creación en 1996, ha querido dar el mejor servicio posible a sus clientes. Siempre decimos que nuestro mejor producto es **nuestro servicio**.

Por ello, y en nuestro constante afán por mejorar, hemos realizado esta edición de nuestro catálogo general de productos. En esta nueva edición nos especializamos aún más si cabe en la Reproducción, principalmente Transferencia Embrionaria y OPU, trayendo al mismo productos innovadores y técnicamente avanzados.

También hemos reforzado las gamas de Diagnóstico, Material Quirúrgico y de Protección, Endoscopia y Monitoring.



Como siempre hemos dicho, solo deseamos serles útiles y poder ofrecerles nuestro mejor producto:

“Nuestro servicio”



 **Humeco**
Productos veterinarios
Consorcio Mercantil de Huesca, S.L.



Índice de familias

REPRODUCCIÓN

| | |
|-----------------------------------|-------|
| Electro-eyaculadores bovino/ovino | 5 |
| Recogida del semen bovino | 6 |
| Diluyentes semen bovino | 6 |
| Aplicación del semen bovino | 7-9 |
| Recogida del semen ovino | 10 |
| Diluyentes semen ovino | 10 |
| Aplicación del semen ovino | 10-11 |
| Inseminación por laparoscopia | 11 |
| Recogida del semen equino | 12 |
| Vagina Missouri | 13 |
| Vagina INRA | 13 |
| Toma de muestras equino | 13 |
| Diluyentes semen equino | 14 |
| Aplicación del semen equino | 14 |
| Transporte semen equino | 14 |
| Inseminación peces | 15 |
| Inseminación avícola | 16-17 |
| Recogida del semen cunicultura | 18 |
| Diluyentes cunicultura | 18 |
| Aplicación del semen cunicultura | 19 |
| Inseminación canina | 19 |
| Recogida del semen porcino | 20 |
| Diluyentes porcino | 21 |
| Envasado semen porcino | 22 |
| Consumibles envasado bolsas | 23 |
| Aplicación del semen porcino | 24-25 |
| Medición grasa dorsal porcino | 25 |
| Evaluación seminal | 26-27 |
| Microscopios | 28-29 |
| Pipetas | 30 |
| Material de laboratorio | 31-33 |
| Maquinaria envasado pajuelas | 34-35 |
| Consumible envasado pajuelas | 36 |
| Envasado manual pajuelas | 37 |
| Congelación del semen | 37-39 |
| Pajuelas | 40 |
| Transporte y almacenaje pajuelas | 41-43 |
| Generador de nitrógeno | 43 |

TRANSFERENCIA DE EMBRIONES

| | |
|------------------------|-------|
| Recolecta de embriones | 44-45 |
| Medios T.E. | 46 |
| Equipos laboratorio | 47 |
| OPU | 48 |
| Equipos laboratorio | 49 |
| Aplicación T.E. | 50 |
| Consumibles T.E. | 51 |

ECOGRAFÍA

| | |
|---------------------------|----|
| IMAGO S | 52 |
| IMAGO | 53 |
| EXAGO | 54 |
| Software para EXAGO | 55 |
| EXAPAD MINI | 58 |
| EXAPAD | 59 |
| Características ecógrafos | 60 |
| Tabla sondas/Accesorios | 61 |
| Easi-Scan | 62 |
| Ovi-Scan | 62 |
| Easi-Scan:Go | 63 |
| Duo-Scan:Go | 64 |
| Accesorios | 64 |
| Características ecógrafos | 65 |

ENDOSCOPIA

| | |
|--------------------------------|----|
| Endoscopios fijos y portátiles | 66 |
| Endoscopios dinámicos | 67 |

SISTEMAS DE CONTROL

| | |
|-----------------------------|----|
| Monitorización partos | 68 |
| Monitorización celos | 68 |
| Monitorización temperatura | 68 |
| Monitorización alimentación | 68 |
| Accesorios monitorización | 69 |
| Geolocalización | 70 |

DIAGNÓSTICO

| | |
|-----------------------------|----|
| Extracción de sangre | 72 |
| Control de temperatura | 72 |
| Auscultación/Otoscopia | 73 |
| Espéculos vaginales | 73 |
| Reactivos | 74 |
| Recogida y toma de muestras | 75 |
| Accesorios | 75 |

MATERIAL QUIRÚRGICO

| | |
|---------------------------|-------|
| Pinzas | 76-78 |
| Tijeras | 79 |
| Porta-agujas | 80 |
| Agujas de sutura y portas | 80-81 |
| Grapas y agujas de sutura | 82 |
| Suturas absorbibles | 83-84 |
| Suturas no absorbibles | 85 |
| Paños/Goteros | 86 |
| Vendas/Gasas | 87 |
| Necropsias | 88 |
| Bisturís | 89 |
| Obstetricia | 90-91 |

JERINGAS

| | |
|---------------------------------|-----|
| Dosificadores bucales/Garrochas | 92 |
| Jeringa intradérmica Dermojet | 93 |
| Revólver Hauptner | 94 |
| Revólver Roux | 95 |
| Jeringas Socorex | 96 |
| Repuestos Socorex | 97 |
| Tuberculina/Cutímetros | 97 |
| Vacunadores | 98 |
| Jeringas desechables/Agujas | 99 |
| Varios jeringas | 100 |

MATERIAL DE PROTECCIÓN

| | |
|-----------------------|---------|
| Guantes | 102-103 |
| Vestuario desechable | 104 |
| Vestuario veterinario | 105 |
| Protección general | 106 |

IDENTIFICACIÓN

| | |
|-------------------------------|-----|
| Crotales ADN | 109 |
| Crotales electrónicos | 110 |
| Microchips | 110 |
| Crotales plástico | 111 |
| Crotales varios | 112 |
| Marcas aves/Pequeños animales | 112 |
| Marcaje | 113 |
| Sacabocados y tijeras | 114 |
| Collares y marcas | 115 |
| Tatuadores de tenaza | 116 |
| Martillos tatuadores | 117 |

MATERIAL GANADERO

| | |
|-----------------------------|---------|
| Empujadores | 118 |
| Inmovilizadores | 118 |
| Destetadores | 119 |
| Narigones y abre bocas | 119 |
| Anillas | 120 |
| Sujeción | 121 |
| Esquiladoras | 122-123 |
| Cepillos/Rasquetas/Peines | 124 |
| Descornadores | 125 |
| Cortacolas | 126 |
| Descolmilladores | 126 |
| Castración | 127 |
| Pistolas de sacrificio | 127 |
| Pediluvios | 128 |
| Arreglo de cascos | 128-129 |
| Pezuñas ovino | 129 |
| Vendas | 130 |
| Pezuñas bovino | 131 |
| Pezotomos/Cánulas mamarias | 132 |
| Ordeño | 132-133 |
| Sondas esofágicas/Trocares | 134 |
| Partos | 135 |
| Cubos/Biberones/Tetinas | 136 |
| Imanes | 137 |
| Cuadra | 137 |
| Lámparas | 138 |
| Bombas dosificadoras | 138 |
| Bebedores vacuno | 139 |
| Bebedores ovino | 139 |
| Bebedores aves/Chupetes | 139 |
| Medición y control | 140 |
| Jaulas/Cepos/Exterminadores | 141 |
| Sulfatadoras | 141 |
| Pastores batería y solares | 142 |
| Pastores eléctricos | 142 |
| Cinta e hilo | 143 |
| Aisladores | 144 |
| Piquetas y mallas | 145 |
| Accesorios pastores | 146 |

NUTRICIÓN

| | |
|-----------------------|-----|
| Piensos y suplementos | 147 |
|-----------------------|-----|

BIOSEGURIDAD

| | |
|------------------------|-----|
| Higiene y desinfección | 148 |
| Secantes de camas | 148 |
| Crema ubres | 149 |
| Lubricación | 149 |

Electro-eyaculadores bovino/ovino



Ref. A127

Pulsator IV

Tiene tres modos de uso: manual, programa y aprendizaje, que le permite al operador un control completo durante el proceso de eyaculación.

El paquete completo viene con el Pulsator IV, el cargador, una sonda, 2 cables de sonda, cinta escrotal, mango colector de semen, 100 conos desechables, 100 viales desechables, estuche de transporte e instrucciones.



Ref. H25-90

Sonda 90 mm
Pulsator IV



Ref. H25-75

Sonda 75 mm
Pulsator IV



Ref. H25-60

Sonda 60 mm
Pulsator IV



Ref. H25R

Sonda ovino 32 mm
Pulsator IV



Ref. H29AA

Electrojac 6

Electroeyaculador para recogida de semen por control remoto. Funciones automática y manual. El equipo incluye un control remoto, generador, sonda, cinta métrica escrotal, batería, mango, cono y viales de recogida, todo dentro de un maletín de transporte.



Ref. H29ADP

Sonda 76 mm
Electrojac 6



Ref. H29AAP

Sonda 64 mm
Electrojac 6



Ref. H29ACP

Sonda 50 mm
Electrojac 6



Ref. H29ABP

Sonda 25 mm
Electrojac 6



Ref. 023917

Gel Lubricante
B-LUBE 500 mL



Ref. H51

Porta cono recolector semen



Ref. B2-7000

Camisa desechable
electroeyaculador P/100 uds



Ref. 7100

Cono ligero bovino látex

Ref. 7110

Cono pesado bovino látex



Recogida semen bovino



Ref. 005417

Vagina artificial bovino



Ref. 005204

Cono vagina bovino



Ref. 005346

Funda protectora vagina bovino



Ref. 001886

Juego juntas tóricas vagina bovino



Ref. 005347

Filtro protector tubo recolección



Ref. 005351

Tubo colector Pirex redondo graduado 15 mL



005332

Ref. 005331

Camisa neopreno lisa bovino

Ref. 005332

Camisa neopreno estriada bovino



026541

Ref. 026647

Camisa látex lisa bovino

Ref. 026541

Camisa látex estriada bovino



Ref. 019757

Agua estéril 1 litro



Ref. 150895

Tubo colector cónico 15 mL P/50 uds

Diluyentes semen bovino



Ref. 026218

OptiXcell 250 mL

Medio concentrado listo para usar. Sin proteínas de origen animal. Optimizado para semen fresco y congelado. Incremento de la movilidad posdescongelación en concentraciones no óptimas. Índice de fertilidad comprobado. Transparente, medio sin partículas.



Ref. 006584

BIOXcell 100 mL C.S.P. 500 mL

Ref. 016218

BIOXcell 250 mL C.S.P. 1250 mL

Diluyente de refrigeración y congelación de semen bovino. Sin proteínas de origen animal. Contiene una mezcla antibiótica de lincomicina, espectinomina, gentamicina y tilosina.



Ref. 020996

Optidyl 500 mL

Medio concentrado listo para usar para la congelación de semen de toro. Contenido: Tris, yema de huevo ionizada, glicerol y antibióticos.



Alpha VISION

Sistema que integra: cámara HD, catéter de inseminación, monitor y aplicación integrados en un teléfono móvil.

Usos potenciales:

- Ayuda en el diagnóstico de problemas reproductivos
- Facilitar el acto de la inseminación
- Identificación de animales que aún no están listos para la reproducción
- Educación y entrenamiento
- Favorecer el bienestar animal
- Reducir el tiempo de manipulación del aparato reproductivo de la vaca
- Registro y almacenamiento de datos relacionados con la inseminación

Ventajas y beneficios:

- Antes de la inseminación: controlar estado del útero y del moco cervical, involución uterina, registrar, analizar y almacenar datos
- Durante la inseminación: reducir tiempo de manipulación del útero (menos contracciones), menos fuerza necesaria, aumentar higiene del semen, eliminar contacto del catéter con la pared vaginal
- Después de la inseminación: controlar reflujos de semen post IA, acceso a una base de datos, ayuda en el diagnóstico y tratamiento veterinario



Ref. 026757
Alphavision



Ref. 025114
Kit inseminación Humeco

Composición del Kit:

- Termómetro
- Tijeras
- Guantes inseminación 92 cm C/100 uds
- Pinza para pajuelas
- Inyector universal Kombicolor
- Camisas sanitarias 530 mm P/80 uds
- Vaina universal Alpha P/50 uds
- Termo descongelación
- Descongelador pajuelas 12V/220V
- Corta pajuelas
- Porta vainas
- Porta inyectores
- Mochila

Aplicación del semen bovino



005563

Camisas sanitarias

| | |
|------------------|--------|
| 430 mm P/100 uds | 006459 |
| 530 mm P/80 uds | 005563 |
| 630 mm P/60 uds | 006458 |

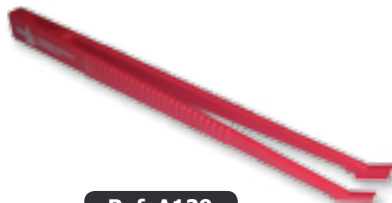

Ref. A129

Pinza plástico para pajuelas



Ref. 005233

Cortador de pajuelas



Ref. 022D

Descongelador pajuelas
12V/220V



Ref. 150740

IFT SmartWarmer

Calentador de inyectores con temperatura controlada. Ideal para mantener los inyectores para inseminación artificial o transferencia de embriones a la temperatura óptima cuando se carga con semen sensible a la temperatura, embriones de FIV o cuando se transportan embriones frescos o congelados/descongelados convencionales en condiciones de frío.



Ref. 82

Parches de celo AITAGS
P/10 uds



Ref. 150685

Descongelador IFT 12V/220V

Especialmente diseñado para monitorear la temperatura durante la descongelación de semen y embriones.

- Rango: 25°C/40°C
- Precisión: +/- 0.4°C
- Tamaño: 16 cm



Ref. 024761

Guantes supersensitivos IMV
C/100 uds



Ref. 024199

Guantes inseminación Polysem
92 cm C/100 uds

Aplicación del semen bovino



Ref. 007494

Vaina universal hendida P/50 uds



Ref. 007497

Vaina universal no hendida P/50 uds



Ref. 006323

Protector vainas



Ref. 024485

Vaina universal **Alpha** P/50 uds

Vaina de inseminación universal de Alta Seguridad IMV

- Cabezal palpable para una perfecta colocación, seguridad y ahorro de tiempo
- Máxima flexibilidad y resistencia. Plástico cristalino ultraliso, visualización óptima de los fluidos
- Mejor colocación de la pajueta, sin reflujo
- Dos salidas laterales, arrastran menos fluidos para una mejor higiene
- Sin cortes, para inyectores Kombicolor y de espiral



Inyectores vacuno

| 0,50 mm | 0,25 mm | Universal |
|---------|---------|-----------|
| 007069 | 007070 | 007071 |



Consultar

Arandelas inyectoras



Ref. 006322

Protector inyector



Ref. 007072

Inyector vacuno universal espiral



Ref. 020267

Inyector vacuno universal Flexia



Inyector vacuno Kombicolor

| | |
|----------|--------|
| Blanco | 018396 |
| Amarillo | 018397 |
| Verde | 018398 |
| Azul | 018399 |
| Rojo | 018400 |

Recogida del semen ovino



Ref. H25R
Sonda ovino 32 mm
Pulsator IV



005205

007179

| | |
|--|--------|
| Vagina artificial ovino/caprino/canino | |
| Vagina artificial | 007179 |
| Cono vagina ovino | 005205 |



Ref. 027512
Camisa vagina artificial ovino



Ref. 005111
Filtro protector vagina ovino

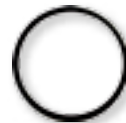

Ref. 001885
Juego juntas tóricas vagina ovino



Ref. 005351
Tubo colector Pirex redondo graduado 15 mL



Ref. 005631
Tubo Pirex 10 mL cónico graduado

Diluyentes semen ovino



Ref. 020997
OVIXCell 100 mL
Diluyente de refrigeración (5°C) y congelación de semen ovino. Sin proteínas de origen animal.



Ref. 016660
Nevera de transporte 21 litros

Aplicación del semen ovino



Ref. 0048
Punta inseminación DARIO
P/200 uds
Dispositivo Anti-Reflujo de Inseminación Ovina.

El reflujo de la dosis es un parámetro importante en el éxito de la inseminación artificial en ovejas. Cuando el semen se deposita al comienzo del cuello uterino, se produce un reflujo de la dosis, reduciendo así la eficacia de la inseminación. DARIO logra una penetración suficientemente profunda y a la vez consigue taponar el orificio del cérvix evitando el reflujo y mejorando hasta un 12% las tasas de fertilidad.

- DARIO se estrecha cónicamente hacia un extremo con punta roma y con 3 orificios de salida: uno central y dos laterales
- DARIO presenta un rebaje o achatamiento lateral para facilitar la visión del inseminador y un canal interior para montar el catéter de inseminación
- DARIO se adapta tanto a la vaina fina como a la miniaturizada, consiguiendo una unión tan fuerte que hace muy difícil que se desprenda de la vaina una vez introducido en ella

Compatible con las pistolas de inseminación de IMV mini y miniaturizada.

Aplicación del semen ovino

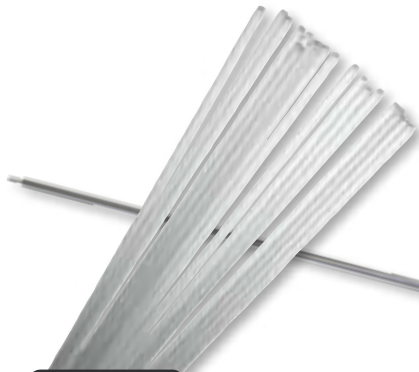

Ref. 006922

Vaina fina P/40 uds

Ref. 007176

inyector fino 0,25 mL



Ref. 007180

Espéculo IMV sin luz



Ref. 006931

Vaina miniaturizada P/40 uds

Ref. 007177

inyector vaina miniaturizada 0,25 mL



018337



016320

Iluminación para espéculo IMV

Lámpara tipo atornillada

016320

Caja pilas 3 V

018337

Ref. 007187

Iluminación Lumistil

Ref. 016321

Bombilla atornillable monobloc

Inseminación por laparoscopia



Ref. 005546

Aspic para pajuela ovina P/25 uds



Ref. 007188

Transcap ovino con guía

| Trocar ovino | | | |
|----------------|--------|---------|--------|
| | ø5mm | ø6,5 mm | ø7 mm |
| Trocar | 007189 | 007840 | 005624 |
| Junta P/10 uds | 007795 | 007899 | 005150 |

Ref. 015025

Pinza presión útero laparoscopia



Ref. 005624

Trocar con pistón ø7 mm



Ref. 017553
Maniquí caballo IMV



Ref. 019665
Gel estéril Priority Care



Ref. 300456
Gel Priority Care 4 L

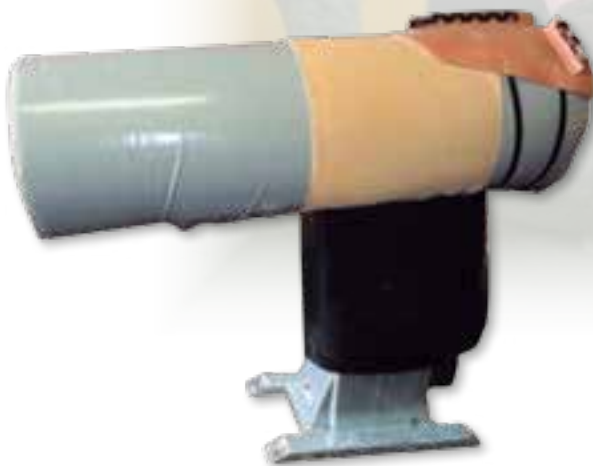

Ref. 100203
Maniquí estándar



Ref. 023917
Gel Lubricante
B-LUBE 500 mL



Ref. 005125
Filtro semen equino
P/25 uds



Ref. 100201
Maniquí confort



Ref. 024260
Bobina funda vagina
desechable equino

Vagina Missouri



Ref. 025599
Vagina artificial Missouri equino IMV



Ref. 005158
Filtro protector escay Missouri



Ref. 005159
Manguito protector fieltro Missouri



Ref. 005175
Camisa uso único con filtro vagina equina P/10 uds



Ref. 005174
Camisa uso único sin filtro vagina equina P/10 uds



Ref. 025598
Funda vagina Missouri 75 cm

Vagina INRA



Ref. 005176
Camisa interna vagina INRA



Ref. 005177
Camisa externa vagina INRA



Ref. 021933
Vagina artificial modelo INRA

Ref. 021937
Cuerpo vagina INRA



Ref. 005200
Cono vagina INRA PVC



Ref. 019265
Elástico para vagina INRA



Ref. 006639
Manguito protector vagina INRA



Ref. 017585
Camisa desechable vagina INRA P/50 uds

Toma de muestras equino



Ref. 007393
Legra 70 cm estéril yegua P/50 uds

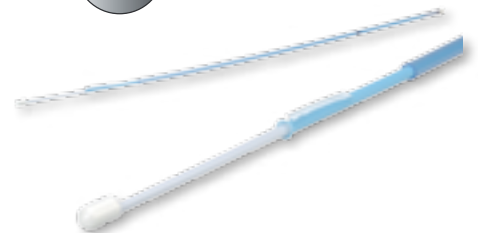

Ref. 290955
Hisopo Equivet P/10 uds

Diluyentes semen equino



Ref. 016441

INRA 96 200 mL

Diluyente de refrigeración y congelación para semen equino, ovino y caprino. Contiene un extracto derivado de la leche. Con penicilina, gentamicina y anfotericina B.



Ref. 019269

Maxifreeze 100 mL

Colchón de centrifugación espermática a base de iodixanol.



Ref. 022110

Kit Inrafreeze

Diluyente de congelación de semen equino con plasma de yema de huevo y glicerol. Estéril y listo para usar.

Aplicación del semen equino

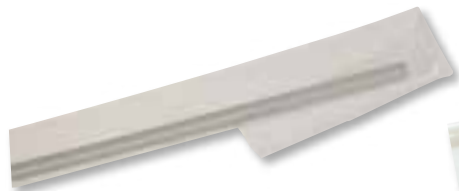

Ref. 007356

Sonda estéril IA equino sin jeringa P/50 uds



Ref. 019839

Sonda estéril inseminación profunda P/50 uds



Ref. 019892

Mandrín para sonda inseminación profunda

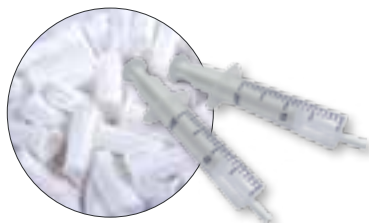

Ref. 017313

Capuchón estéril LUER jeringa 20 mL P/50 uds



Ref. 024761

Guantes supersensitivos IMV C/100 uds



Ref. 024199

Guantes inseminación Polysem 92 cm C/100 uds

Transporte semen equino



Ref. 005096

Equitainer con kit



Ref. 005260

Caja refrigerante Equitainer



Ref. 005249

Bolsa Ballast



Ref. 005644

Whirl-pack 177 mL

Inseminación peces



ProSorter



Ref. 027000

Clasificador de huevos de salmónidos ProSorter

Clasificador profesional que usa tecnología de procesamiento de imágenes.

- Precisión muy alta para eliminar huevos transparentes, huevos con ojos diminutos y huevos no fecundados
- Sin posclasificación manual
- Sin mortalidad posclasificación
- Los huevos demasiado pequeños o demasiado grandes son rechazados
- 125.000 – 200.000 huevos clasificados hora/máquina
- Autoajustable y autónoma
- Tanque intermedio de alta capacidad (20 L)
- Estadísticas fiables sobre el tamaño, la variación del mismo y la calidad de los huevos

QuickSorter



Clasificador de huevos de salmónidos QuickSorter

| Cilindro 5,25 | Cilindro 6,25 | Cilindro 7,25 | Cilindro 8,25 | Cilindro 9,25 |
|---------------|---------------|---------------|---------------|---------------|
| 017509 | 019104 | 017510 | 018538 | 017511 |

El clasificador más rápido con sistema de detección actualizado.

- Velocidad muy alta para retirar huevos sin fecundar
- 1 millón de huevos por hora
- Fiable y preciso
- Sin mortalidad posclasificación
- Contadores de lotes clasificados
- Fácil de usar y autónomo
- Práctico y transportable con una bomba externa
- Fácil de limpiar y resistente



Ref. 018500 STORFISH

Medio para conservación de esperma de la mayoría de las especies de peces (trucha, rodaballo, dorada, carpa, bagre...) durante 4-6 días a 4.2°C.



Ref. 026950 OVAFISH

Medio para la dilución y limpieza de los huevos de los salmónidos antes de la fecundación artificial (salmónidos, peces marinos y peces de agua dulce).



Ref. 018274 ACTIFISH

Medio para la dilución de los espermatozoides de salmónidos para la inseminación artificial. Permite practicar la inseminación artificial con semen fresco, refrigerado o congelado.



Ref. 026520 FREEZEFISH

Medio de crioconservación de semen de peces de agua dulce. Hasta un 90% de fertilización después de la descongelación. Adaptado a todas las especies.



Ref. 027775 MARINEFREEZE

Diluyente diseñado para la conservación y la cripreservación de semen de peces marinos y de tilapia.



Inseminación avícola



| Tubo recolección semen | |
|---------------------------------|--------|
| Tubo aspiración lg 260 P/100uds | 006450 |
| Tubo conector boca P/100 uds | 007299 |
| Boquillas de succión P/100 uds | 007811 |



Ref. 006363
Catéter Gallus B/2x50 uds



| Colector semen P/2x25 uds | |
|---------------------------|--------|
| 5 mL | 10 mL |
| 006442 | 006443 |



Ref. 006929
Cánula especial pava
P/100.000 uds



Ref. 007163
Inyector pajuelas 1,2 mL
con sistema volumétrico



Ref. 005591
Pajuela avícola 1,2 mL
P/50 uds



Medio avícola
conservación semen P/50 uds

| | 4 mL | 5 mL |
|--------|--------|--------|
| Pavos | 020070 | 025580 |
| Gallos | 020070 | |

| Diluyentes Pintadas P/100 uds | | |
|-------------------------------|----------------------------------|------------------------------------|
| Medio pintada 2,5 mL | Medio con ciprofloxacina 1 mL | Medio con ciprofloxacina 1,5 mL |
| 022165 | 002263 | 002267 |

Ref. 002262
Medio pavo 2,5 mL
P/100 uds



Ref. 018111
Medio Ovodyl 100 mL



Ref. 002268
Medio pato Canadyl 25 mL
P/100 uds

Inseminación avícola



Ref. 007155

M.R.A.
Máquina envasadora semi-automática con contador. Tiene un sistema de bombeo patentado que asegura una dosificación regular. La unidad puede ser sumergida completamente en una solución jabonosa.



Ref. 019250

Kit motorización M.R.A.



Ref. 007161

Jeringa llenado M.R.A.



Ref. 007799

Espéculo aves

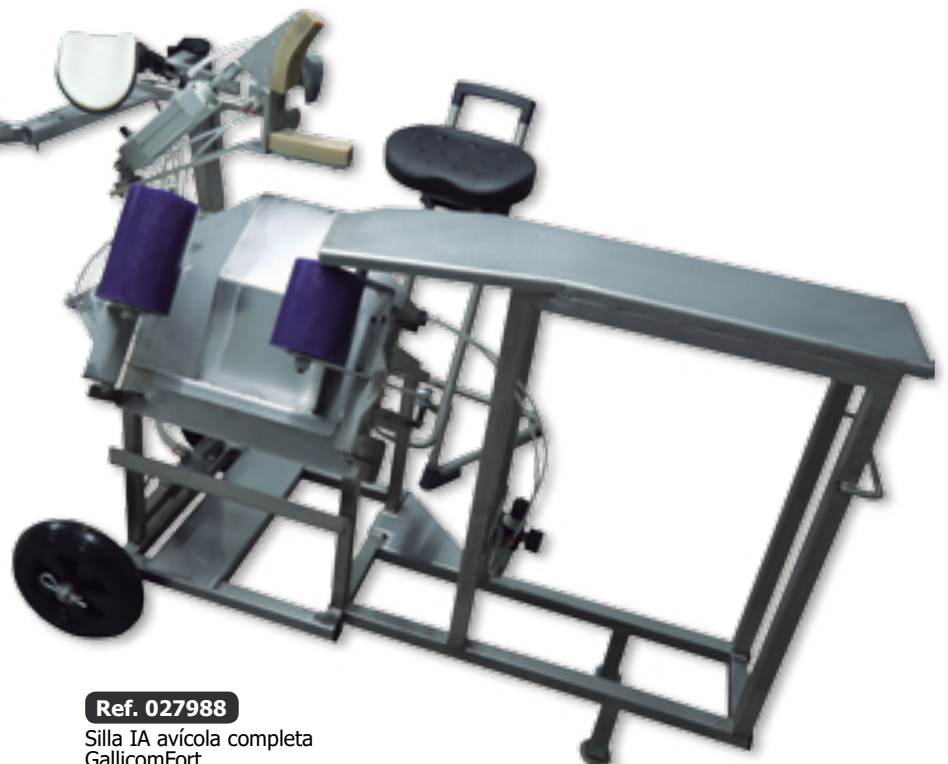

Ref. 027988

Silla IA avícola completa
GallicomFort

Recogida del semen/Diluyentes cunicultura



Ref. 007220
Vagina artificial conejos



Ref. 000319
Sitio de inyección vagina conejos



Ref. 024914
Cunigel 1,2 litros
Diluyente en fase gel para la refrigeración de esperma fresco de conejo, esterilizado por filtración, listo para su empleo.



Ref. 127
Vagina conejos silicona



Ref. 001884
Junta estanca vagina conejos C/5 uds



Ref. 017743
Capote neopreno P/10 uds



Ref. 005349
Tubo recolecta conejos 10 mL



| Galap | |
|--------|---------|
| 500 mL | 1 litro |
| 002285 | 016388 |

Diluyente de conservación del esperma fresco de conejo, esterilizado por filtración, listo para su empleo. Contiene antibióticos: penicilina, estreptomina y enrofloxacina. Conservación del semen de conejo durante 72 horas.

Aplicación del semen cunicultura



Ref. 007264
Inyector curvado 255 mm



Ref. 006928
Cánula conejos recta P/100 uds



| Pajuelas conejos P/100 uds | |
|----------------------------|--------------|
| Tapón rojo | Tapón blanco |
| 006796 | 006428 |

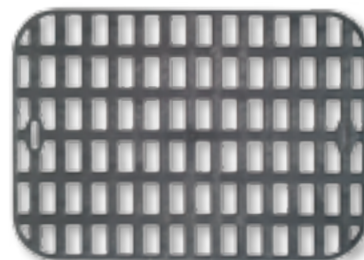

Ref. 102
Bandeja suelo Cuniflex

Aplicación del semen cunicultura



Cánulas monodosis flexibles P/50 uds

| Tapón negro | Tapón rojo | Tapón verde |
|-------------|------------|-------------|
| 501090 | 99412 | 99413 |

Cánulas monodosis para la inseminación en cunicultura

La inseminación con las cánulas monodosis es análoga a la que se hace con otros sistemas solo que se simplifica la introducción de la cánula porque no hay que tener ninguna precaución en cuanto a la posición de la cánula. La cánula monodosis entra suavemente hasta el fondo de la vagina, sin causar ningún tipo de malestar y sin riesgo de introducción en la uretra.

Son desechables, por lo que se reduce a cero el riesgo de contagios con cánulas mal esterilizadas. Se evitan las heridas típicas de la inseminación, utilizando cánulas de caucho flexibles, lo que hace que el productor no necesite saber del tema.

Facilita y agiliza el trabajo evitando accidentes de manejo habituales con los sistemas tradicionales de I.A.



Ref. 501092

Jeringa multidosis IA conejos

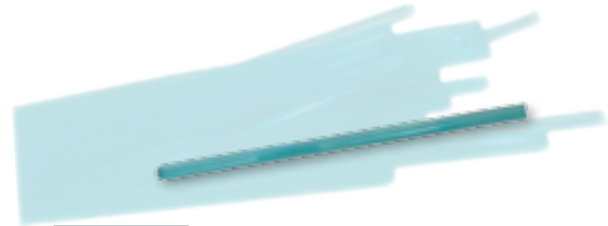

Ref. 015416

Cánula conejos recta corta P/100 uds

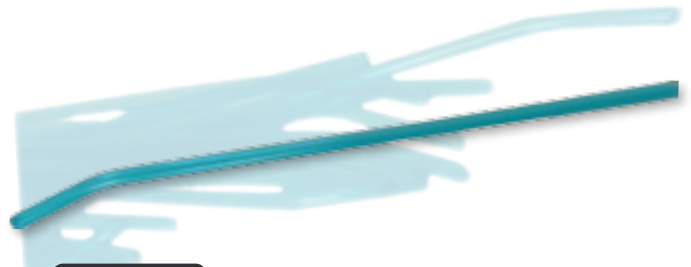

Ref. 006927

Cánula conejos curva P/100 uds

Inseminación canina



Ref. 021728

CaniFreeze

Medio para la congelación de los espermatozoides caninos a -196°C . Estéril y listo para su empleo, contiene lipoproteínas purificadas de la yema de huevo (LDL).



Ref. 014650

Pajuelas 0,50 mL



Ref. 007300

Sonda Osiris para semen fresco



Ref. 150171

Histeroscopia

Recogida del semen porcino



Ref. 021044

Potro de recogida reforzado



Ref. 021038

COLLECTIS

El nuevo estándar para la recogida de semen porcino.

- **Mayor productividad:** dos veces más eficiente que la recogida manual; el mismo número de recogidas por hora, con la mitad de personal
- **Mayor calidad seminal** mediante el empleo de una vagina artificial aislada para una higiene óptima de la recogida
- **Mejor entorno de trabajo:** más seguro, menos contacto con el verraco. Más cómodo: menor tiempo en posturas incómodas (de rodillas, etc.)
Entrenamiento de los nuevos operarios más fácil y rápido



100215

015096

Producto

| | |
|----------------------------------|---------------|
| Potro de recogida transportable | 100215 |
| Alfombrilla de caucho 150x100 cm | 015096 |



017282

350217

100265

005251

Accesorios recogida

| | |
|----------------------------------|---------------|
| Filtros 230 mm Ø P/200 uds | 350217 |
| Termo recogida blanco | 017282 |
| Vaso graduado 400 mL | 005251 |
| Vasos recogida desechable 300 mL | 100265 |



Ref. 021041

Cono azul Collectis
C/150 uds



Ref. 021082

Membrana azul
Collectis



Ref. 021042

Liners Collectis
P/1000 uds

Diluyentes porcino



Ref. 5001544

VERRACHOC 5 kg

- Aumenta la calidad y cantidad del semen
- Reduce formas anormales en el esperma
- Evita procesos inflamatorios a nivel testicular



| PRIMXcell | |
|-----------|--------|
| 1 L | 5 L |
| 021055 | 021056 |

- Diluyente de corta duración
- La fórmula base original (Beltsville Thawing Solution) mejorada
- Ingredientes de alta calidad
- Contiene antibióticos de alta calidad



Ref. 019757

Agua estéril 1 litro



| FERTIDYL | | | |
|----------|--------|--------|--------|
| 1 L | 5 L | 10 L | 50 L |
| 022917 | 022918 | 022919 | 022920 |

- Diluyente de larga duración
- Contiene Bioactivator
- No contiene productos de origen animal
- Polvo blanco para reconstituir con agua purificada
- Contiene una combinación de antibióticos



Ref. 150153

**Nevera conservación semen
140 litros**



Ref. 026804

APROCELL 50L

- Diluyente de larga duración
- Contiene Bioactivator
- No contiene productos de origen animal
- Polvo blanco para reconstituir con agua purificada
- Contiene una combinación de antibióticos

| | Tiempo de conservación | Antibióticos | Cumple Normativa CEE 90/429 | Antioxidantes | Libre de proteínas sanguíneas | Reguladores de pH | Bioactivator | Tº de conservación mínima | Tº de conservación máxima |
|--|------------------------|--------------|-----------------------------|---------------|-------------------------------|-------------------|--------------|---------------------------|---------------------------|
| | 3 días | ◇◇ | ● | | ● | ◇ | | 16º | 18º |
| | 6 días | ◇◇◇ | ● | ◇◇◇ | ● | ◇◇ | | 16º | 18º |
| | 6 días | ◇◇◇◇ | ● | ◇◇◇ | ● | ◇◇◇ | | 16º | 18º |

BioACTIVATOR
Efecto potenciador demostrado sobre la motilidad y la fertilidad en granja

Envasado semen porcino



Ref. 024488
GTB 1000 V3

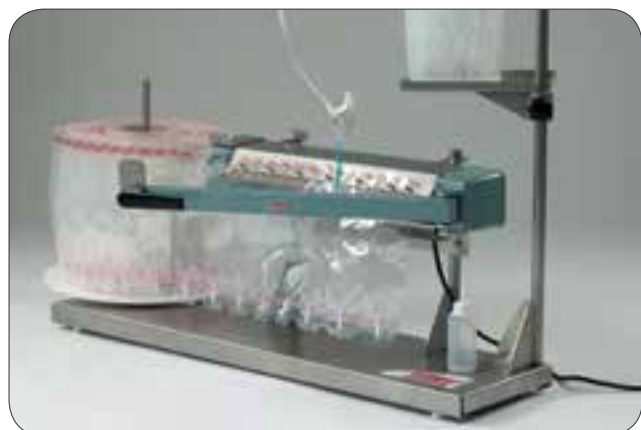

Ref. 022267
Envasadora manual GTB 250
Máquina envasadora y selladora manual. El flujo del semen se controla manualmente mediante un clamp. La velocidad de llenado es de 250 bolsas GTB por hora.



La GTB 1000 envasa, sella, etiqueta y corta de manera automática más de 1000 bolsas GTB por hora. La precisión de llenado se ha mejorado en comparación con los otros sistemas de llenado existentes, con un margen de error de tan solo +/- 1 g. Una única persona es capaz de controlar la máquina mientras realiza otras tareas en el laboratorio. Funciona con aire comprimido (6 bares). No se suministra con compresor.



Ref. 021010
Envasadora GEDIS serie 900



Ref. 021034
Envasadora GEDIS serie 500



Ref. 027111
Envasadora GoldenFilled



Ref. 023737
GEDIS



Ref. 026690
GoldenFix

Consumibles envasado bolsas



Ref. 022331
Bolsa GTB 80 mL



Ref. 025881
Bolsa BACTIBAG

El primer blíster diseñado con un plástico inteligente para prevenir el desarrollo de bacterias en el semen porcino

BactiBag® es la innovación más reciente de IMV Technologies en materia de almacenamiento de semen de cerdo para responder al creciente desafío de controlar la contaminación bacteriana en el semen.

El BactiBag® es un componente de una solución completa que le permite evitar el desarrollo de bacterias en el semen porcino.



Ref. 021911
Mini bolsa GTB 40 mL



Ref. 021571
Etiquetas GTB
R/2000 uds



Bolsa Dilbag R/100 uds

| | |
|------------|------------|
| 8,3 litros | 3,8 litros |
| 005284 | 005285 |

BactiBag y nivel de bacterias

BactiBag aumenta la conservación del semen a largo plazo

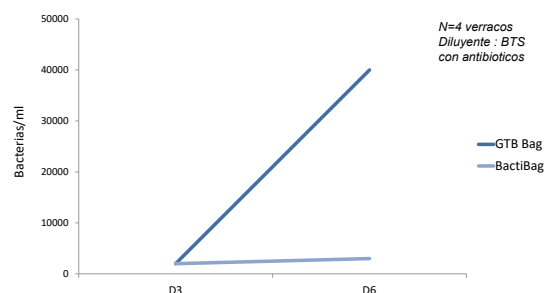

BactiBag resultados in vivo

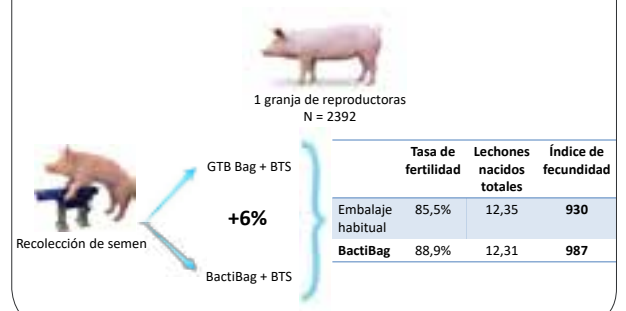

Aplicación del semen porcino



Ref. 006957

Sonda espuma Goldenpig IMV
C/750 uds

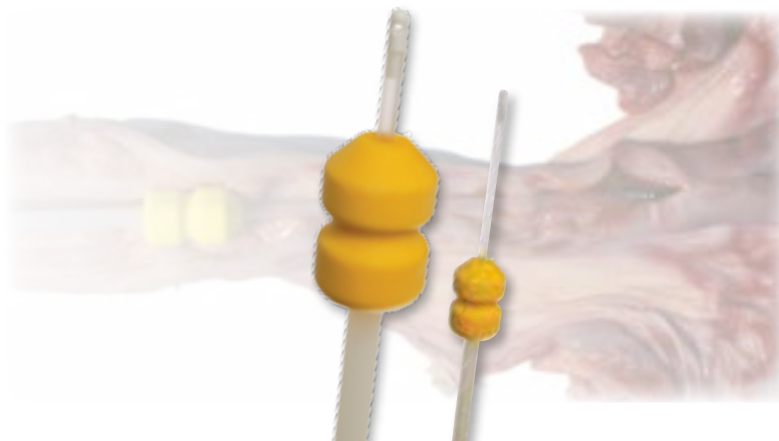

Sonda espuma intrauterina
Deepgoldenpig CIII

| | |
|--------------|----------|
| Caja 500 uds | P/25 uds |
|--------------|----------|

| | |
|--------|--------|
| 018252 | 023540 |
|--------|--------|



Ref. 016624

Sonda espuma Goldengilt IMV
C/750 uds



Toallitas desinfección

| | |
|---------|---------|
| 150 uds | 900 uds |
|---------|---------|

| | |
|---------|---------|
| 6410337 | 6410339 |
|---------|---------|



Ref. 023917

Gel Lubricante
B-LUBE 500 mL



Gel Bovinet

| | | |
|--------|---------|----------|
| 500 mL | 1 litro | 5 litros |
|--------|---------|----------|

| | | |
|--------|--------|--------|
| 300453 | 300454 | 300455 |
|--------|--------|--------|



Bote inseminación 100 mL P/500 uds

| | |
|-------|---------|
| Color | 0,25 mL |
|-------|---------|

| | |
|--------|--------|
| Blanco | 150181 |
|--------|--------|

| | |
|----------|--------|
| Amarillo | 150185 |
|----------|--------|

| | |
|-------|--------|
| Verde | 150182 |
|-------|--------|

| | |
|------|--------|
| Rojo | 150184 |
|------|--------|

| | |
|------|--------|
| Azul | 150183 |
|------|--------|



Ref. 5001834

Manta detección celo



Ref. 150163

Lubrinet 1 litro



Ref. 016174

Cinturón Innovia cerdas



Aplicación del semen porcino



Ref. 026730

Sonda espuma + trasera CRYO-VET
C/500 uds



Ref. 026731

Sonda espuma intrauterina CRYO-VET
C/500 uds

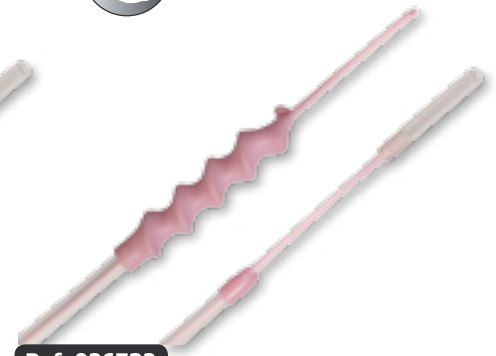

Ref. 026732

Sonda intrauterina espiral CRYO-VET
C/500 uds



Guantes vinilo Krutex sin polvo

| T/P | T/M | T/L | T/XL |
|--------|--------|--------|--------|
| 700241 | 700243 | 700245 | 700247 |



Guantes nitrilo Krutex

| T/P | T/M | T/L | T/XL |
|--------|--------|--------|--------|
| 700251 | 700253 | 700255 | 700257 |



Guantes látex Krutex

| | T/P | T/M | T/L | T/XL |
|-----------|--------|--------|--------|--------|
| Sin polvo | 700221 | 700223 | 700225 | 700227 |
| Con polvo | 700231 | 700233 | 700235 | 700237 |

Medición niveles de grasa porcino



BioSoft
TOOLBOX II



Ref. 556

BioSoft Toolbox II

Software de análisis de grasa dorsal e intramuscular y tamaño del ojo de lomo en porcino.

BioSoft Toolbox® II para cerdos ofrece a las empresas de cría de cerdos y engorde la herramienta de apoyo por ultrasonidos más completa que se haya desarrollado y comercializado. BioSoft Toolbox® II permite analizar la acumulación de grasa dorsal e intramuscular de sus animales, además del tamaño del ojo de lomo. Esto le permite clasificar sus animales según la calidad de la carne, seguir con precisión la condición corporal de sus hembras y optimizar sus decisiones en la granja.

El Software BioSoft para cerdos es fácil de usar y está en continuo desarrollo, una de las principales mejoras es el procesamiento automático de las profundidades de grasa y lomo de las imágenes capturadas longitudinalmente. Esta característica permite al usuario determinar el número de medidas de profundidad de grasa y lomo que se incluirán en las mediciones medias para estos rasgos. La capacidad de programar campos personalizados de animales y campos de medición de imágenes le ofrece la mayor flexibilidad.

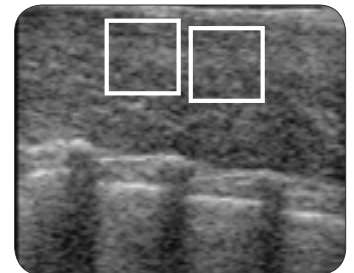

Funciona con el ecógrafo EXAGO y la sonda de medición de grasa específica para porcino

Evaluación seminal

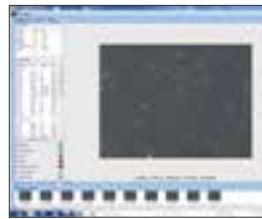

Software de nueva generación: control de inicio del análisis, selección de configuración, resultados de análisis, imagen y miniatura del último campo analizado

Ref. 024911

Analizador de semen IVOS II

Ref. 024910

Analizador de semen IVOS II Fluorescencia

- Morfología automática
- Cálculo de las dosis (concentración, volumen de diluyente, número de dosis)
- Microscopio y pletina calentable incorporada
- Cámara numérica de alta velocidad
- Rapidez (8 segundos para 10 células)
- Nuevo diseño de la interfaz gráfica
- Navegación intuitiva
- Multilingüe
- Creación ilimitada de los parámetros predefinidos
- Base de datos integrada, resumen personalizado
- Exportación de los datos en formato ASCII



Ref. 024905

Analizador de semen CEROS II

- Sistema CASA dirigido a la producción de dosis seminales en porcino
- Análisis de concentración, motilidad, cinética y análisis en línea (RTM: Real-Time Morphology) de morfología espermática
- Posibilidad de guardar y reanalizar capturas
- Permite el estudio de trayectorias individuales y subpoblaciones
- Menús específicos para producción de dosis y control de calidad
- Máxima exactitud y precisión



022843



022841

Ref. 022841

EasyCyte 96 pocillos

Ref. 022843

EasyCyte mini tubo

Citómetro de flujo con un amplio panel de tests de evaluación (carga bacteriológica, potencial mitocondrial, capacitación, integridad acrosómica, fragmentación nuclear...). Hasta 96 muestras simultáneas.

Ventajas

- Adaptado para la evaluación espermática
- Sistema patentado de microcapilar: sin fluido de vaina, menos residuos biológicos, menos cantidad de reactivos
- Protocolos de IMV listos para usar
- Paquete de software intuitivo
- Apoyo técnico científico
- Tecnología fácil de usar



Ref. 96ISB

iSperm

Sistema de análisis seminal. Con iSperm, el análisis de esperma es más fácil que nunca. Integrada en un iPad mini, una lente óptica optimizada permite el examen microscópico con resolución óptica excepcional.

El software analiza la concentración de espermatozoides y su motilidad e informa del número de dosis a realizar con el eyaculado.

Evaluación seminal



| Fotómetro ACCUREAD | |
|--------------------|--------|
| Porcino | 019951 |
| Equino | 019954 |
| Ovino | 019955 |
| Bovino | 019956 |
| Pato | 019952 |
| Pavo / Gallo | 019953 |
| Canino | 021376 |

Este fotómetro, transportable y de volumen reducido, puede funcionar tanto por corriente eléctrica de red como con batería. Lectura directa de la concentración gracias a un diodo emisor de luz (LED) combinado con una fibra óptica (ausencia de filtros, mayor precisión).

El fotómetro Accuread da el resultado tanto en absorbancia como en concentración. Por otro lado, tiene una salida RS 232 para comunicación a PC o impresora.



| Fotómetro ACCUCCELL | |
|---------------------|--------|
| Porcino | 014434 |
| Equino | 014435 |
| Ovino | 014436 |
| Caprino | 014437 |
| Avícola | 014439 |
| Bovino | 014475 |

Un instrumento desarrollado para una medición exacta de la concentración de eyaculaciones usando una ecuación cuadrada.

- Lectura directa de la concentración; cálculo de la absorbancia o la concentración. La unidad también calcula el volumen de medio a añadir y el número potencial de dosis
- Concentración: visualización simultánea de la concentración y la absorbancia
- Conexión RS232



Ref. U-H

μHandy

Convierte la mayoría de móviles y smartphones en un microscopio portátil. Se integran las capacidades de un microscopio convencional con la cámara y el sistema operativo del móvil.

Permite realizar un análisis básico en las siguientes situaciones:

- Comprobar la motilidad masal de un eyaculado
- Comprobar la motilidad de una dosis seminal
- Análisis de formas anormales más evidentes (colas)
- Estimación subjetiva de la concentración seminal



Dilutor

| | |
|---------|--------|
| Bovino | 023724 |
| Porcino | 023725 |
| Equino | 023726 |



| Microcélulas LEJA para sistema CASA | |
|-------------------------------------|-----------|
| 4 puestos | 8 puestos |
| 025107 | 025108 |



Ref. 005155

Cubetas fotómetro P/100 uds

Microscopios



*Con pletina
incorporada
bajo pedido*

Ref. 150101

Microscopio Binocular
B-500 BipH OPTIKA



*Con pletina
incorporada
bajo pedido*

Ref. 150105

Microscopio Binocular
B-382 OPTIKA



Ref. 150109

Microscopio Binocular
B-192 OPTIKA



*Con pletina
incorporada
bajo pedido*

Ref. 150075

Microscopio Binocular
E-200 NIKON



*Con pletina
incorporada
bajo pedido*

Ref. 150077

Microscopio Trinocular
E-50 NIKON



*Con pletina
incorporada
bajo pedido*

Ref. 150103

Microscopio Trinocular
B-500 TpHi OPTIKA



*Con pletina
incorporada
bajo pedido*

Ref. 150106

Microscopio Trinocular
B-383 OPTIKA



Ref. 150111

Microscopio Monocular
BP-20 R batería OPTIKA



Ref. 4083.13E

Cámara OPTIKAM
HDMI Easy

Microscopios



Ref. 300001
Placa calentable
ZUZI serie 100

Ref. 300007
Placa calentable digital
con pletina para microscopio

Ref. 300005
Placa calentable digital



Ref. 300003
Pletina calentable portátil
PlatCal



| Cubre objetos | | |
|---------------|-----------|-----------|
| | C/100 uds | C/200 uds |
| 18x18 | 150081 | 150086 |
| 22x22 | | 150080 |
| 24x24 | 150082 | 150087 |
| 24x32 | 150083 | |



Ref. 150089
Cubre objetos cámaras recuento
espermatozoides P/10 uds

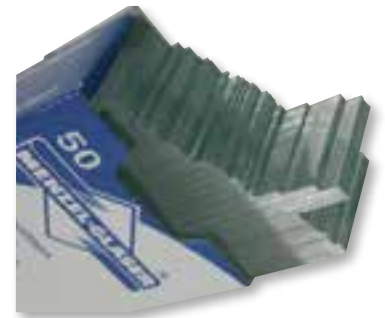

Ref. 150079
Porta objetos P/50 uds



Ref. 005786
Cámara Thoma



Ref. 150121
Cámara Burkert



Ref. 150125
Cámara de Neubauer

Pipetas



150878

300037

| Pipetas | |
|------------------------|--------|
| P20 2-20 μ l | 150875 |
| P100 10-100 μ l | 150876 |
| P200 20-200 μ l | 150877 |
| P1000 100-1000 μ l | 150878 |
| P5000 0,5-5 mL | 150879 |

| Micropipeta volumen fijo | |
|--------------------------|--------|
| 100 μ l | 300031 |
| 200 μ l | 300033 |
| 500 μ l | 300035 |
| 1000 μ l | 300037 |



Ref. 150881

Punta pipeta 20-200 μ l
P/1000 uds



Ref. 150884

Punta pipeta 100-1000 μ l
P/1000 uds



Ref. 150885

Punta pipeta 0,5-5 mL
P/250 uds



Ref. 150869

Aspirador manual de pipetas



Ref. 150871

Pipeta plástico PASTEUR 1 mL P/500 uds



Ref. 150873

Pipeta cristal PASTEUR 1 mL P/250 uds



| Soporte pipetas | |
|-----------------|-----------|
| 4 pipetas | 6 pipetas |
| 150891 | 150893 |



Ref. 150131

Nigrosina soluble



Ref. 150133

Eosina amarillenta



Ref. 150134

Eosina - Nigrosina listo para usar 25 mL



Ref. 600821

Contador manual



Ref. 150084

Aceite de inmersión 100 mL



Ref. 150141

Seripettor

Material de laboratorio



151073

Vaso de precipitado

| | |
|----------|--------|
| 50 mL | 151071 |
| 100 mL | 151079 |
| 250 mL | 151072 |
| 400 mL | 151073 |
| 600 mL | 151074 |
| 1 litro | 151075 |
| 2 litros | 151076 |
| 3 litros | 151077 |
| 5 litros | 151078 |



151062

Probeta graduada

| | |
|----------|--------|
| 50 mL | 151061 |
| 100 mL | 151062 |
| 250 mL | 151063 |
| 500 mL | 151064 |
| 1 litro | 151065 |
| 2 litros | 151066 |

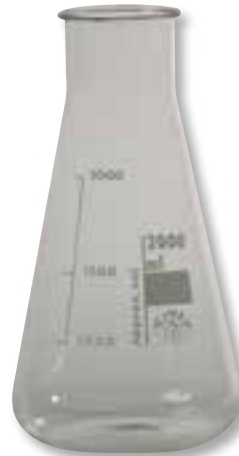

151082

Matraz Erlenmeyer

| | |
|----------|--------|
| 250 mL | 151085 |
| 1 litro | 151081 |
| 2 litros | 151082 |
| 3 litros | 151083 |
| 5 litros | 151084 |



151092

Matraz aforado con tapón

| | |
|--------|--------|
| 50 mL | 100 mL |
| 151091 | 151092 |

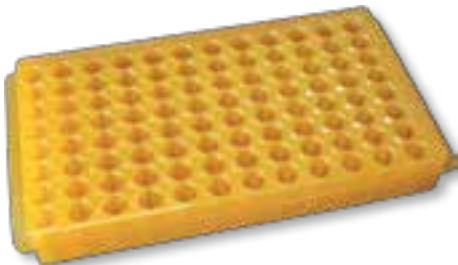

Ref. 150809

Gradilla reversible para 96 microtubos



Gradilla inoxidable

| | |
|-------------------|--------|
| 6x4 tubos 10 mm Ø | 150707 |
| 6x4 tubos 14 mm Ø | 150709 |
| 6x4 tubos 18 mm Ø | 150711 |
| 6x4 tubos 22 mm Ø | 150713 |



Gradilla forma Z

| | |
|-----------------|--------|
| Tubos 12,2 mm Ø | 150701 |
| Tubos 14 mm Ø | 150703 |
| Tubos 17 mm Ø | 150705 |



Ref. 290778

DipQuick kit 3x500 mL



Jarra plástico

| | |
|----------|----------|
| 3 litros | 5 litros |
| 6410324 | 6410325 |



Ref. 150715

Gradilla universal plástico

Material de laboratorio



Ref. 151013
Agitador rotativo



Ref. 151017
Agitador magnético con calefacción 5 litros

151018
Imán agitador



| Tubo centrífuga P/50 uds | | |
|--------------------------|------------------|------------------|
| 15 mL | 50 mL sin faldón | 50 mL con faldón |
| 150895 | 150897 | 150899 |



Ref. 151001
Centrífuga C2004



Ref. 151011
Agitador de tubos tipo Vortex



150801

| Tubo Eppendorf P/500 uds | |
|--------------------------|--------|
| 1,5 mL | 2 mL |
| 150801 | 150803 |



Ref. 151006
Micro centrífuga Micro Star 12



Ref. 151005
Centrífuga refrigerada

Material de laboratorio



151023

Baño limpieza ultrasonidos

| | |
|------------|------------|
| 1,6 litros | 5,7 litros |
| 151023 | 151025 |



Ref. 151027

Baño maría plástico digital 12 litros



151031

Baño maría acero inoxidable

| | |
|-------------------|--------|
| Digital 5 litros | 151026 |
| Digital 12 litros | 151029 |
| Digital 20 litros | 151031 |



Estufa secado y esterilización

| | |
|-----------|-----------|
| 40 litros | 90 litros |
| 151041 | 151043 |



Ref. 151131

Balanza portátil 300 gr precisión 0,01 gr



Ref. 151133

Balanza 600 gr precisión 0,001 gr



150153

Nevera conservación

| | | |
|------------|------------|------------|
| 140 litros | 360 litros | 600 litros |
| 150153 | 150151 | 150152 |



Ref. AES-28

Autoclave semiautomático 28 litros

Maquinaria envasado pajuelas



Ref. 027034

ISevo Alpha 0,25 mL

Ref. 026979

ISevo Alpha 0,50 mL

ISevo Alpha es un compromiso. El compromiso de trabajar de manera segura y rápida, con total confianza y silencio. Resultante de 9 patentes, este nuevo concepto combina tecnología de vanguardia e inteligencia, garantizando un embalaje perfecto. Es más que una máquina de llenado de pajuelas; es una revolución.

Tranquilidad:

- Control automático del nivel de humedad del tapón
- Posibilidad de ver el llenado en una pantalla remota que garantiza un proceso seguro

Ahorro de tiempo:

- Ciclo de inicio corto
- Ciclo rápido 4x4 (12,500 pajuelas/hora)
- Limpieza rápida y fácil
- No se necesita controlar visualmente el llenado

Llenado y sellado eficiente:

- Pajuela Alpha específicamente diseñada para absorber menos semen
- Hasta un 5% más de pajuelas minis que con los actuales consumibles y equipos convencionales

Ergonomía inteligente:

- Tres botones inteligentes mejoran la comodidad del usuario y la velocidad de reacción
- Está diseñado para ser más fácil de desmontar y limpiar

Trazabilidad única:

- Ambas versiones, integradas y no integradas, permiten mantener un registro del lote de pajuelas y del operador que utilizó el equipo
- En la versión no integrada, una opción con un sistema de código de barras único permite al usuario verificar que el toro y la pajuela impresa correspondan

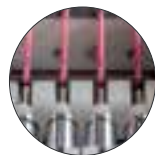

ISevo Alpha



Pajuelas Alpha transparentes

| | |
|-----------------------|----------------------|
| 0,25 mL C/2000 uds | 0,50 mL C/900 uds |
| 025653 | 026182 |

La pajuela Alpha patentada permite el control automático del nivel de humedad del tapón, lo que ayuda a evitar posibles pérdidas durante la descongelación. Su tapón de color se vuelve fluorescente cuando está correctamente humedecido y sellado. Con su diseño hidrofóbico, la pajuela Alpha crea una nueva referencia en pajuelas de baja absorción.

Ref. 027036

ISevo Alpha sistema integrado 0,25 mL

Ref. 027035

ISevo Alpha sistema integrado 0,50 mL



Maquinaria envasado pajuelas



Ref. 019792

IS4 con impresora 0,25 mL

Ref. 019794

IS4 con impresora 0,50 mL

Este sistema integrado llena, sella e imprime las pajuelas IMV a una velocidad de 12.500 pajuelas/hora. Totalmente dirigido por ordenador, su sistema permite la impresión de códigos de barras (garantía de la trazabilidad de los eyaculados) dejando también un espacio suficiente para los datos clásicos.

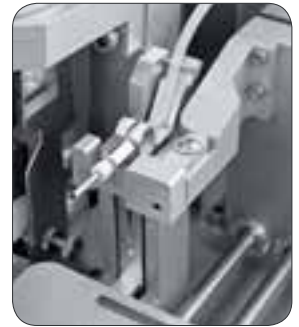

De fácil manejo, la IS4 está totalmente cubierta y establece nuevos estándares tanto en términos de confort de uso (poco ruido) como por su diseño.

Envasadora automática de pajuelas de 0,25 mL y 0,5 mL. Se puede trabajar tanto a temperatura ambiente como a 4°C. Rápida: 3.600 pajuelas a la hora. Carros de distintos tamaños: 100, 58 y 40 pajuelas.

- Conversión rápida y fácil de pajuelas mini a medianas o de medianas a mini
- Componentes mecánicos reducidos
- Funcionamiento silencioso debido a un motor paso a paso controlado electrónicamente
- Parada automática al final del ciclo del carro
- La parada mecánica ajustable permite al usuario preestablecer el número de pajuelas llenas y selladas



Ref. 022989

Máquina envasado MRS1 V2



Ref. 023845

Máquina envasado GENOM' X

GENOM'X

Máquina de llenado y soldado de pajuelas, para pajuelas finas y medianas

- 0% de semen absorbido con el sistema de llenado
- Más pajuelas
- Optimización de la concentración: concepto de 'Burbuja'
- Mejor preservación de las características del semen
- Rápido retorno de la inversión
- Fácilmente reemplazable
- Mejor visualización

Producción: 10.000-13.000 pajuelas finas por hora, 10.000-12.000 pajuelas medianas por hora



Concepto de burbuja:

Al aspirar el medio de conservación con el semen se crea una burbuja entre una pequeña cantidad para empapar el tapón y el resto de la dosis

Consumible envasado pajuelas



Ref. 025430

Cono aspiración semen desechable MRS1 P/65 uds



Aguja llenado desechable

L 290 mm L 450 mm

025302 025352



Tubo aspiración semen

Tubo MRS1 35 cm P/60 uds **005564**

Tubo IS4 29 cm P/60 uds **017484**



Ref. 010240

Tapón estanqueidad 0,50 mL P/5000 uds



Aguja larga llenado pajuelas

0,50 mL 0,25 mL

007703 007704



Aguja corta aspiración pajuelas

0,50 mL 0,25 mL

007705 007706



Ref. 008199

Servicio de impresión de pajuelas

Impresión de pajuelas, tanto en mini (0,25 mL) como maxi (0,50 mL), identificación alfanumérica, código de barras. Disponibilidad en 48 horas.



Calibre pajuelas MRS1

100 pajuelas de 0,25 mL **022887**

58 pajuelas de 0,25 mL **022888**

100 pajuelas de 0,50 mL **022889**

58 pajuelas de 0,50 mL **022890**

Servicio de impresión de pajuelas



(tamaño real)



Consumibles Lynx 500 cc

Tinta Disolvente

FA91240 FA91512

Envasado manual pajuelas



| Peine de llenado | |
|------------------|---------|
| 0,50 mL | 0,25 mL |
| 007297 | 007298 |



Ref. 007006
Bomba aspiración con filtro



| Barqueta - Depósito del semen P/25 uds | |
|--|---------|
| 0,50 mL | 0,25 mL |
| 006935 | 006936 |



Ref. 007116
Soporte barqueta acero inoxidable



| Polvo sellador 750 gr | |
|-----------------------|--------|
| Amarillo | 018815 |
| Rojo | 018816 |
| Verde | 018817 |
| Azul | 018818 |
| Violeta | 018819 |
| Naranja | 018820 |

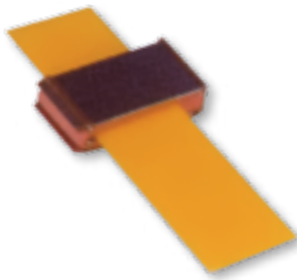

| Pinza sujetapajuelas | |
|----------------------|---------|
| 0,50 mL | 0,25 mL |
| 007008 | 007009 |

| Recambio caucho | |
|-----------------|---------|
| 0,50 mL | 0,25 mL |
| 007876 | 007875 |



Se toman las pajuelas por la boca de aspiración y se introducen dentro del semen diluido. La bomba de aspiración llenará las pajuelas.



Las pajuelas se insertan en el peine. De esta manera se vaciará el extremo final de la pajuela, detalle fundamental para evitar su explosión durante el proceso de congelación.

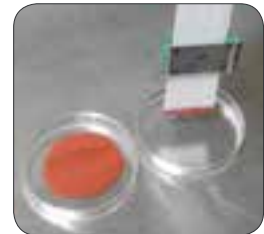

El haz de pajuelas se coloca sobre una placa con el polvo sellador y después sobre una placa de petri con agua purificada, así las pajuelas quedan perfectamente selladas.

Congelación de semen



Ref. 007136
Soporte 3 huecos cubilete 65 mm



Ref. 005524
Pinza corta distancia 23 cm



Ref. 005523
Pinza larga distancia 70 cm

Congelación de semen



Ref. 007262
Digitcool 30 rampas



Ref. 007263
Mini-Digitcool 24 rampas



Tanque nitrógeno presurizado

| | |
|------------|--------|
| 60 litros | 020086 |
| 120 litros | 007223 |
| 180 litros | 007222 |



Ref. H1001

Congelador semen manual L1000

- Capacidad: 25 pajuelas por ciclo
- Consumo por ciclo: 1 litro nitrógeno
- Peso: 9,5 kg
- Medidas: 38 x 24 x 33 cm



Ref. 007261

Micro-Digitcool 6 rampas



| | Ref. | Volumen | Consumo nitrógeno | Potencia | Capacidad pajuelas |
|-----------------|--------|------------|-------------------|-----------------------|------------------------------------|
| Digitcool | 007262 | 150 litros | 13 a 15 litros | 2500 W (2 x 1250W) | 3.000 (0,50 mL) 5.250 (0,25 mL) |
| Mini-Digitcool | 007263 | 90 litros | 8 a 10 litros | 2500 W (2 x 1250W) | 1.392 (0,50 mL) 2.400 (0,25 mL) |
| Micro-Digitcool | 007261 | 26 litros | 6 a 8 litros | 2500 W (2 x 1250W) | 240 (0,50 mL) 420 (0,25 mL) |

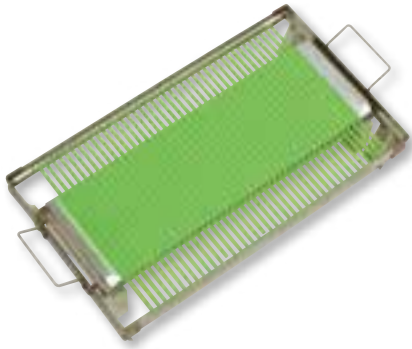

El antiguo proceso de congelación directa sobre vapor de nitrógeno líquido crea una curva de congelación que es difícil de controlar y puede dar lugar a una baja reproducibilidad.

El proceso de congelación programable de Digitcool permite al usuario personalizar y controlar cada fase de mantenimiento o descenso de temperatura acorde con los requisitos de la muestra.

Congelación de semen



| Rampa de congelación | | | Capacidad Pajuelas | |
|---|-----------------|---------|--------------------|----------------|
|  | Digitcool | 0,25 mL | 007120 | 175 de 0,25 mL |
| | | 0,50 mL | 007117 | 100 de 0,50 mL |
|  | Mini-Digitcool | 0,25 mL | 007121 | 100 de 0,25 mL |
| | | 0,50 mL | 007118 | 58 de 0,50 mL |
|  | Micro-Digitcool | 0,25 mL | 007122 | 70 de 0,25 mL |
| | | 0,50 mL | 007119 | 40 de 0,50 mL |

| Bloque de distribución | | | Capacidad Pajuelas | |
|---|-----------------|---------|--------------------|----------------|
|  | Digitcool | 0,25 mL | 007089 | 175 de 0,25 mL |
| | | 0,50 mL | 007091 | 100 de 0,50 mL |
|  | Mini-Digitcool | 0,25 mL | 007090 | 100 de 0,25 mL |
| | | 0,50 mL | 007092 | 58 de 0,50 mL |
|  | Micro-Digitcool | 0,25 mL | 007088 | 70 de 0,25 mL |
| | | 0,50 mL | 007093 | 40 de 0,50 mL |



imv
TECHNOLOGIES



| Cuba nitrógeno MCA | |
|--------------------|---------|
| 0,25 mL | 0,50 mL |
| 023153 | 023154 |



| Contador pajuelas automática | |
|------------------------------|---------|
| 0,25 mL | 0,50 mL |
| 015691 | 015760 |

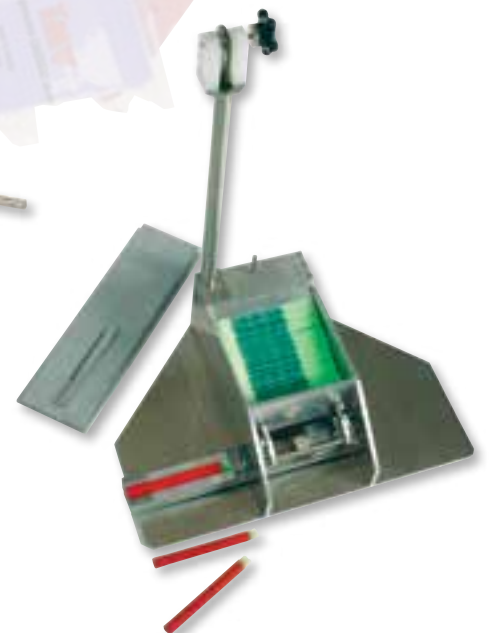

Ref. 007095
Contador pajuelas manual

Pajuelas



| Pajuelas | 0,25 mL P/2000 uds | | | 0,50 mL P/2000 uds |
|-----------------|-----------------------|--------|---------------|-----------------------|
| | Clásica | TBS | Ovino/Caprino | Clásica |
| Transparente | 005565 | 017011 | 006429 | 005569 |
| Rojo | | | | 005702 |
| Verde | 005570 | | | 005568 |
| Parma | 005573 | | | 005703 |
| Amarillo | 005578 | | 006808 | 005707 |
| Rosa | 005581 | 019707 | | 005712 |
| Azul | 005680 | | 006813 | |
| Salmón | 005582 | 019708 | 006815 | 005715 |
| Pistacho | | 019709 | | 005746 |
| Rojo pastel | 005567 | 017012 | | 005709 |
| Azul pastel | 005584 | 017014 | | 005697 |
| Gris pastel | 005577 | 017015 | | 005698 |
| Amarillo pastel | 005575 | 017016 | | 005590 |
| Naranja pastel | 005580 | 017017 | | 005685 |
| Verde pastel | | 017013 | 021464 | 005710 |
| Pistacho pastel | 019179 | 018888 | | 020201 |
| Parma pastel | 019130 | 021702 | | |
| Blanco | | 018299 | | |
| Beige | 005585 | | 006816 | 005711 |

| Pajuelas STOP'EX 0,25 mL P/2000 uds | |
|--|--------|
| Blanco | 023223 |
| Transparente | 023224 |
| Azul pastel | 023225 |
| Azul turquesa | 023226 |
| Amarillo fluorescente | 023227 |
| Amarillo pastel | 023228 |
| Rojo | 023229 |
| Rojo transparente | 023230 |
| Rosa fluorescente | 023231 |
| Verde fluorescente | 023232 |
| Verde pastel transparente | 023233 |
| Verde transparente | 023234 |
| Púrpura | 023235 |
| Naranja fluorescente | 023236 |
| Naranja pastel | 023237 |
| Marrón claro | 023238 |
| Marrón | 023239 |
| Gris plata | 023240 |



| Pajuela 0,25 mL semen fresco P/2000 uds | |
|--|--------|
| Blanco | 006937 |
| Gris | 006939 |
| Amarillo | 006942 |
| Rojo | 006941 |
| Azul | 006940 |
| Verde | 006938 |

Servicio de impresión de pajuelas



Transporte y almacenaje pajuelas



Visotubo Hexagonal

| | |
|----------|--------|
| Blanco | 006875 |
| Rojo | 006398 |
| Verde | 006394 |
| Azul | 006409 |
| Amarillo | 006414 |
| Naranja | 006405 |



**Visotubo redondo
ø 13 mm**

| | |
|----------|--------|
| Blanco | 006420 |
| Rojo | 006404 |
| Verde | 006413 |
| Azul | 006395 |
| Amarillo | 006411 |
| Naranja | 006689 |



**Visotubo redondo
ø 12 mm**

| | |
|----------|--------|
| Blanco | 006677 |
| Rojo | 006408 |
| Verde | 006679 |
| Azul | 006678 |
| Amarillo | 006695 |
| Naranja | 006683 |



Cubiletos

| | |
|------------------|--------|
| 35 mm ø blanco | 006934 |
| 65 mm ø blanco | 006418 |
| 65 mm ø rojo | 006397 |
| 65 mm ø verde | 006754 |
| 65 mm ø azul | 006755 |
| 65 mm ø parma | 006757 |
| 65 mm ø amarillo | 006756 |
| 65 mm ø pistacho | 006753 |

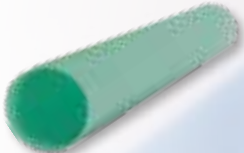

**Visotubo redondo
ø 10 mm**

| | |
|----------|--------|
| Blanco | 005561 |
| Rojo | 006392 |
| Verde | 006406 |
| Azul | 006422 |
| Amarillo | 006402 |
| Naranja | 006673 |

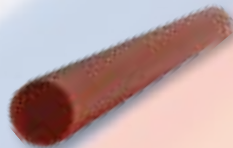

**Visotubo redondo
ø 9,2 mm**

| | |
|----------|--------|
| Blanco | 006421 |
| Rojo | 006668 |
| Verde | 006390 |
| Azul | 006400 |
| Amarillo | 006423 |
| Naranja | 006667 |

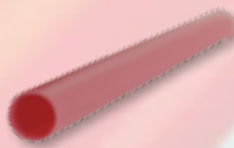

**Visotubo redondo
ø 7,1 mm**

| | |
|----------|--------|
| Blanco | 006658 |
| Rojo | 006441 |
| Verde | 006659 |
| Azul | 006399 |
| Amarillo | 006412 |
| Naranja | 006662 |



Canister P/10 uds

| | |
|---------|--------|
| 2 pisos | 007147 |
| 3 pisos | 007148 |
| 4 pisos | 007149 |
| 5 pisos | 007150 |
| 6 pisos | 007151 |



Visotubo poligonal

| | |
|----------|--------|
| Blanco | 006401 |
| Rojo | 006622 |
| Verde | 006623 |
| Azul | 006620 |
| Amarillo | 006624 |
| Naranja | 006619 |



Junquillos 137 mm P/100 uds

| | | |
|----------|---------|---------|
| Color | 0,25 mL | 0,50 mL |
| Blanco | 006330 | 006762 |
| Rojo | 006777 | 006763 |
| Gris | 006787 | 006774 |
| Amarillo | 006332 | 006331 |
| Rosa | 006779 | 006876 |
| Naranja | 006786 | 006775 |



Elevador canisters

| | |
|-----------|-----------|
| 2 alturas | 3 alturas |
| 015078 | 007913 |



Ref. 007145

Placa con mango
P/100 uds



Consultar

Inglete plástico varios colores
P/200 uds

Transporte y almacenaje pajuelas



Tanques transporte en seco



BS2002 **BS2004**

Tanques bajo consumo



B2002 **B2003**

Tanques gran capacidad



B2013 **B2015** **B2016**

Tanques bajo consumo



B2008 **B2011** **B2020** **B2036**

Tanques gran capacidad



B2026 **B2034** **B2035** **B2048**

| | Capacidad útil | Ø cuello (mm) | Autonomía estática | Pajuelas 0,25 mL | Pajuelas 0,50 mL |
|--------|----------------|---------------|--------------------|------------------|------------------|
| BS2002 | 1,85 | 35 | 23 | 220 | 100 |
| BS2004 | 4,6 | 70 | 19 | 1640 | 730 |
| B2002 | 2 | 35 | 25 | 474 | 210 |
| B2003 | 4,1 | 51 | 42 | 1.560 | 720 |
| B2008 | 8,6 | 51 | 95 | 1.560 | 720 |
| B2011 | 12 | 51 | 133 | 2.700 | 1.200 |
| B2020 | 21,7 | 51 | 238 | 2.700 | 1.200 |
| B2036 | 35,9 | 51 | 365 | 2.700 | 1.200 |

| | Capacidad útil | Ø cuello (mm) | Autonomía estática | Pajuelas 0,25 mL | Pajuelas 0,50 mL |
|-------|----------------|---------------|--------------------|------------------|------------------|
| B2013 | 13 | 89 | 59 | 4.920 | 2.190 |
| B2015 | 15,8 | 89 | 71 | 9.840 | 4.380 |
| B2016 | 16,4 | 51 | 120 | 2.025 | 900 |
| B2026 | 26 | 89 | 104 | 8.200 | 3.650 |
| B2034 | 35 | 89 | 125 | 8.200 | 3.650 |
| B2035 | 35,9 | 89 | 211 | 9.840 | 4.380 |
| B2048 | 48,5 | 119 | 180 | 16.400 | 7.300 |

Tanques almacenamiento BF



| | Capacidad útil | Ø cuello (mm) | Pajuelas 0,25 mL | Pajuelas 0,50 mL |
|--------|----------------|---------------|------------------|------------------|
| BF2350 | 401 | 800 | 426.400 | 189.800 |
| BF2110 | 131 | 480 | 121.360 | 54.020 |



Ref. 005887
Cabezal dispensador nitrógeno



Ref. 43
DryShipper 3.0

El primer tanque de nitrógeno seco desechable para el transporte de muestras biológicas.

- Capacidad de nitrógeno líquido: 3.0 litros
- Peso cargado: 5,1 kg
- Autonomía: 4 días
- Diámetro del canister: 35 mm
- Capacidad: 200 pajuelas 0,25 mL, 100 pajuelas 0,50 mL o 20 criotubos 2,00 mL

Permitido para transporte aéreo IATA reglamento A152

Transporte y almacenaje pajuelas



Tanques transporte en seco



YDH 3-50 **YDH 8-80**

Tanques almacenamiento



YDS 20-50 **YDS 35-50**

Tanques transporte



YDS 1-30 **YDS 2-30** **YDS 3-50**

Tanques almacenamiento/transporte



YDS 35-90 **YDS 35-125** **YDS 47-127**

Tanques transporte



YDS 6-50 **YDS 10-50** **YDS 10A** **YDS 12-90**

| | Capacidad útil | Ø cuello (mm) | Autonomía estática | Pajuelas 0,25 mL | Pajuelas 0,50 mL |
|------------------|----------------|---------------|--------------------|------------------|------------------|
| YDS 1-30 | 1 | 30 | 9 | 115 | 55 |
| YDS 2-30 | 2 | 30 | 16 | 180 | 90 |
| YDS 3-50 | 3 | 50 | 16 | 1.500 | 750 |
| YDS 6-50 | 6 | 50 | 32 | 1.500 | 750 |
| YDS 10-50 | 10 | 50 | 100 | 1.500 | 750 |
| YDS 10A | 10 | 50 | 100 | 2.400 | 1.200 |
| YDS 12-90 | 12 | 90 | 55 | 5.280 | 2.580 |

| | Capacidad útil | Ø cuello (mm) | Autonomía estática | Pajuelas 0,25 mL | Pajuelas 0,50 mL |
|-------------------|----------------|---------------|--------------------|------------------|------------------|
| YDH 3-50 | 3,5 | 50 | 25 | 400 | 200 |
| YDH 8-80 | 8 | 80 | 16 | 1.600 | 800 |
| YDS 20-50 | 20 | 50 | 200 | 2.400 | 1.200 |
| YDS 35-50 | 35 | 50 | 320 | 2.400 | 1.200 |
| YDS 35-90 | 35 | 90 | 185 | 9.600 | 4.800 |
| YDS 35-125 | 35 | 125 | 116 | 22.680 | 11.340 |
| YDS 47-127 | 47 | 127 | 139 | 22.680 | 11.340 |

Generador de nitrógeno

ELAN2 es un generador de nitrógeno líquido, aprovecha la fuente más abundante que es el aire. La tecnología que equipa el sistema ELAN2 ha sido probada con éxito en multitud de usos industriales y con elevado nivel de servicio. El secreto de la fiabilidad del ELAN2 es un ciclo de refrigeración de auto-limpieza desarrollada en MMR Technologies.

El generador de nitrógeno líquido ELAN2 elimina completamente la necesidad del aprovisionamiento y almacenamiento. El nitrógeno está disponible cuando se necesita.

El sistema integra diferentes equipos de seguridad, evitando problemas de dispensación o derrames accidentales.

El ciclo de limpieza mantiene una alta eficacia en el tiempo y está libre de CFC que daña la capa de ozono.



Ref. ELAN

Generador nitrógeno líquido ELAN2

Suministro eléctrico:

- Voltaje: 115 VAC / 230 VAC
- Fase: Monofásico
- Frecuencia: 50Hz / 60Hz
- Energía: ~900 W

Entorno operativo:

- Temperatura: 16°C a 25°C
- Humedad: <80% de humedad relativa
- Polvo: Estándar Oficina de Medio Ambiente (entornos polvorientos requieren el reemplazo del filtro más frecuentemente)

Producción de nitrógeno líquido:

- Tasa de producción: 6 - 8 litros por día
- Capacidad: 20 litros (0,095 litros al día de evaporación estática)
- Pureza: 98,6% (<1% de oxígeno)

Dimensiones:

- Generador: 37 cm de ancho x 37 cm de profundidad x 94 cm de altura (59 kilogramos)

TRANSFERENCIA DE EMBRIONES

Recolecta de embriones

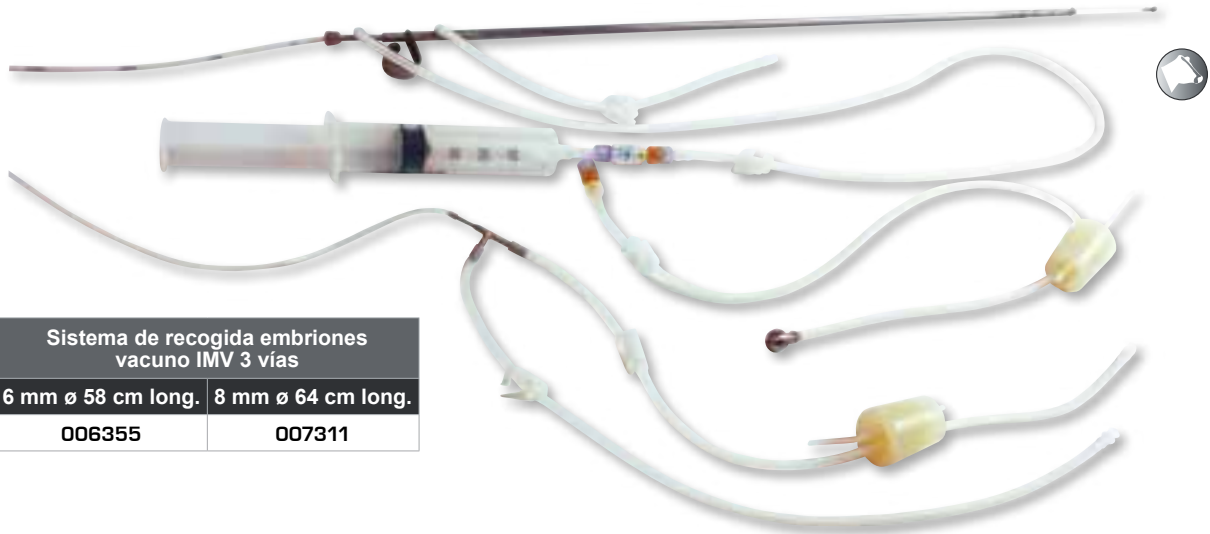

| Sistema de recogida embriones vacuno IMV 3 vías | |
|---|--------------------|
| 6 mm Ø 58 cm long. | 8 mm Ø 64 cm long. |
| 006355 | 007311 |

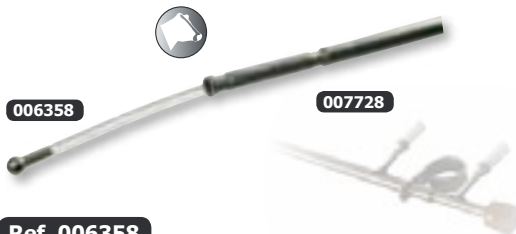

Ref. 006358

Catéter extensible telescópico para sonda vacuno IMV de 6 mm Ø P/5 uds

Ref. 007728

Cuerpo catéter 6 mm Ø long 58 cm



007388

Ref. 007388

Catéter extensible telescópico para sonda vacuno IMV de 8 mm Ø P/5 uds

Ref. 007830

Cuerpo catéter 8 mm Ø long 64 cm



Ref. 006448

Balones desechables para equipos de 3 vías IMV P/5 uds



Ref. 005606

Sonda estéril recolección embrión equino Bivona



Ref. 007312

Conjunto gravedad + tapón + clamp para sonda Bivona equino P/2 uds

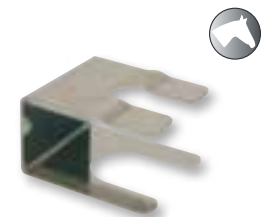

Ref. 007778

Clip racord frasco/sonda para sonda Bivona equino



Ref. 007245
Dilatador cervical



| Fiador | |
|------------------------------|------|
| 50,8 cm para CH14 o inferior | E23 |
| 63,5 cm para CH14 o inferior | E23A |
| 50,8 cm para CH16 o mayor | E24 |
| 63,5 cm para CH16 o mayor | E24A |

TRANSFERENCIA DE EMBRIONES

Recolecta de embriones



| Sonda tipo Luer Agtech silicona estéril | | | |
|---|------|------|------|
| | CH16 | CH18 | CH20 |
| Balón 30 mL | E202 | E203 | E204 |
| Balón 40 mL | | E205 | |



Ref. E27

Tubo en Y Agtech sin filtro catéter Foley



| Sonda tipo Foley silicona estéril Agtech | | | | | | | | |
|--|------|------|------|------|------|------|------|------|
| | CH14 | CH16 | CH18 | CH20 | CH22 | CH28 | CH32 | CH36 |
| Balón 5 mL | E112 | E100 | E102 | E104 | E106 | | | |
| Balón 30 mL | | E101 | E103 | E105 | E107 | | | |
| Balón 80 mL | | | | | | E108 | E109 | E110 |

| Sonda EQUIVET silicona CH33 | |
|-----------------------------|--------|
| 65 cm | 135 cm |
| 340846 | 340847 |

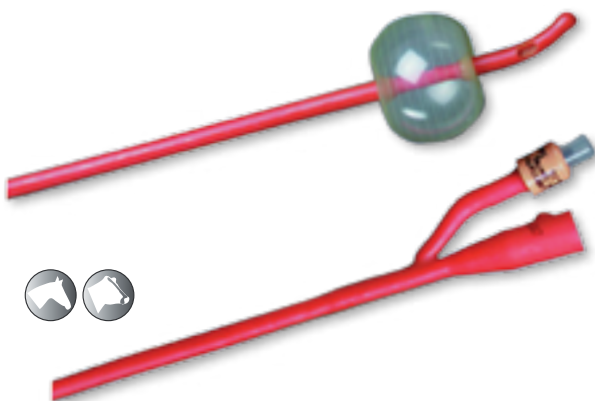

| Sonda tipo Foley látex 46 cm | | | | | | |
|------------------------------|------|------|------|------|------|------|
| | CH14 | CH16 | CH18 | CH20 | CH22 | CH24 |
| Balón 5 mL | E02 | E03 | E04 | E05 | E06 | E07 |
| Balón 30 mL | E09 | E10 | E11 | E12 | E13 | E14 |



Ref. D02

Filtro en copa EMCON



Ref. 017726

Filtro EZ para sondas Foley

TRANSFERENCIA DE EMBRIONES

Medios T.E.



Ref. 019450

Medio de recogida EUROFLUSH

Para vacuno y equino 1 litro, contiene carbohidratos, sales minerales, antioxidantes, buffer, antibióticos, albúmina sérica bovina, rojo fenol y agua ultra pura.



Ref. 019446

Medio de congelación de embriones con glicerol 20 mL P/4 uds



Ref. 021678

VitriXcell

Medio de vitrificación embrionaria porcina.

Kit de 5 medios estériles listo para usar:

- Recolecta
- Vitrificación etapa 1
- Vitrificación etapa 2
- Recalentamiento
- Transferencia



Ref. 019447

Medio de congelación de embriones con etilenglicol 20 mL P/4 uds



Ref. EQU030

Kit de vitrificación embrionaria equina



Ref. C33

Bolsa de medio flushing BioLife 2 litros

Recomendado para la recogida de embriones bovinos y equinos.

- Medio completo y listo para usar. No es necesaria suplementación sérica ni antibiótica. No es necesaria refrigeración
- Medio transparente y estéril producido según los exigentes estándares de calidad de Agtech



Ref. 019449

Medio mantenimiento embrión IMV P/4 uds 20 mL



Ref. 019448

Medio de descongelación de embriones con glicerol y sacarosa



Ref. 019451

Medio de descongelación de embriones en 1 paso 10 mL P/4 uds



Ref. C22A

Solución de tripsina

Equipos laboratorio



Ref. 014498

Microaspirador de ruleta
0,50 mL T.E.

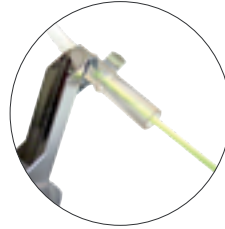

Capilares estériles T.E. P/13 uds

| | Bovino | Equino | Equino D8 |
|--|--------|--------|-----------|
| | 006324 | 018930 | 006359 |



Microdispensador Transferpettor

| | Microdispensador | Capilares |
|-------|------------------|-----------|
| 20 µl | 613-3364 | 613-3371 |
| 50 µl | 613-3366 | 613-3373 |



Ref. D22

Microdispensador 5 µl



Ref. D23

Capilares vidrio 5 µl
P/100 uds



Ref. TE501

Filtro 0,22 micras filtración
de medios P/50 uds

Análisis y laboratorio

HUMECO cuenta con un Laboratorio Biotecnológico y un Laboratorio de Microbiología.

El Laboratorio Biotecnológico desarrolla pruebas de calidad de dosis seminales, verificaciones y calibraciones de aparatos, así como pruebas confidenciales de desarrollo y validación de productos. Dichos servicios se completan con la oferta de formación personalizada a técnicos de centros de inseminación, la asesoría técnica y las auditorías.

El Laboratorio de Microbiología de HUMECO da servicio de cultivo, identificación y antibiograma en muestras clínicas veterinarias.

Un servicio rápido y acorde a las nuevas demandas del sector.

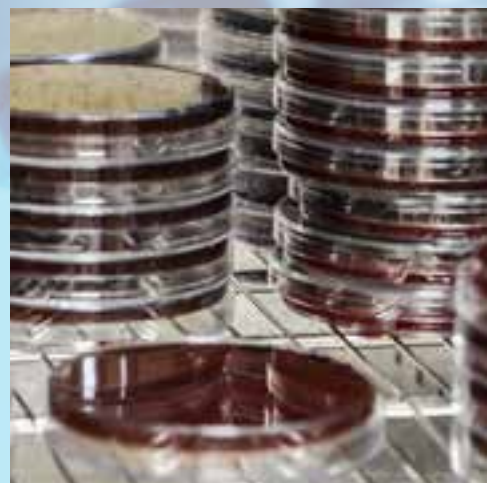

TRANSFERENCIA DE EMBRIONES

OPU

Ref. 90-3001

Sonda + guía Ovum Pick Up novillas

- Diseño fino, ideal para usar en novillas y yeguas
- Guía metálica para la aguja con entrada ajustada y exacta a la aguja
- Montaje rápido, fácil de usar: Ahorro de tiempo entre animales
- Visualización de la aguja instantánea, línea de seguimiento graduada en mitad de la pantalla (Línea de biopsia graduada) (Visualización de folículos de 2 mm)
- Compatible con agujas largas y cortas
- De uso en muchas especies: vacuno, equino, animales salvajes...
- Limpieza y desinfección fácil y rápida



Ref. 025

Bomba aspiración ovocitos Pioneer Pro-Pump

- Pedal doble: alta y baja presión de succión
- Rango de vacío de 0 a 500 mmHg
- Kit de botella reutilizable (incluido)
- Funcionamiento silencioso



Ref. 026688

Incubador Planer BT37

Incubador de sobremesa para ovocitos y embriones

- El mejor entorno para producción de embriones in vitro
- Mayores tasas de fecundación
- Mejor calidad de ovocitos y embriones
- Alta repetibilidad
- Mejores resultados globales
- Control óptimo de la temperatura, gas y humedad
- Batería de respaldo incorporada
- Admite la más amplia selección de platos de cultivo
- Alarmas visuales y sonoras

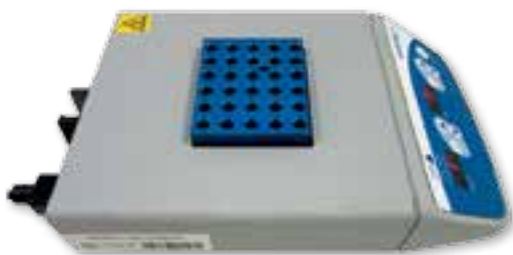

Calentador de tubos

| Analogico (Precisión +/- 1,5°C) | Digital (Precisión +/- 0,2°C) |
|------------------------------------|----------------------------------|
| 460-3249 | 460-3267 |



Ref. 460-3247

Monobloque combinado



Agujas de bisel corto C/100 uds

| 18G | 22G |
|---------|---------|
| 4665120 | 4667093 |



Ref. CLS11706

Tubo colector para OPU



Ref. DI-0222

Tubo de aspiración enrollado B/5 m

TRANSFERENCIA DE EMBRIONES

Equipos laboratorio



Ref. 015468

Lupa trinocular SMZ745T NIKON



Ref. 015469

Lupa binocular SMZ745 NIKON



Lupa binocular LED OPTIKA

| SZM-1 | SZM-2 |
|--------|--------|
| 100221 | 100223 |



Ref. IQ-1-T295

MicroQ iQ1T

Micro Q proporciona un control de temperatura muy preciso durante el transporte de ovocitos, embriones y semen. Con una resolución de 0,0625°C en condiciones ambientales que van desde - 35°C a 60°C.



8800SYS

Biocongelador

| CL-2200 | CL-3300 | CL-5500 | CL-8800 |
|---------|---------|---------|---------|
| 2200SYS | 3300SYS | 5500SYS | 8800SYS |

Todos los biocongeladores Cryogenic son sistemas modulares y las piezas se pueden intercambiar entre ellos. Cada sistema consta de un regulador de temperatura, una criocámara, un criobañó y un estuche para el transporte.

Capacidad variable: hasta 85 pajuelas de 0,25 mL y hasta 15 criotubos de 1 mL, según módulos.

- Rango de temperaturas: +20°C to -43°C
- Programas preinstalados : 8
- Seeding manual



Ref. 025547

Soldadora pajuelas alta seguridad SYMS III

Soldadora manual térmica para pajuelas de alta seguridad CBS y pajuelas de vitrificación HSV.



2200SYS



5500SYS

TRANSFERENCIA DE EMBRIONES

Aplicación T.E.

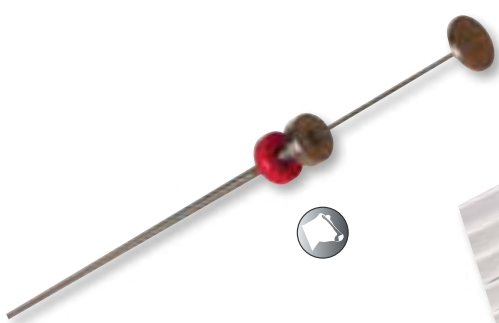

Ref. 007239

Pistola T.E. para vaina de 4,1 mm



Ref. 006385

Vaina para pistola de 4,1 mm
P/10 uds

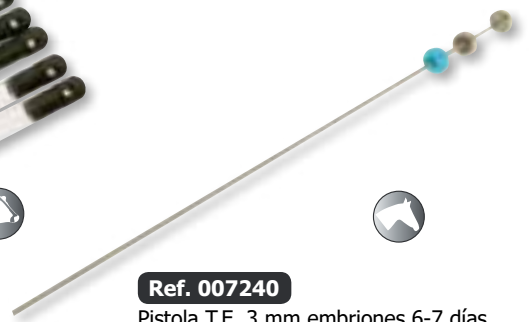

Ref. 007240

Pistola T.E. 3 mm embriones 6-7 días

Ref. 007246

Pistola de 3 mm con cámara profunda para pajuela no cortada



Ref. 007241

Pistola telescópica



Ref. 006454

Tubo flexible "Aspibryon"
jeringa telescópica P/5 uds

Ref. 006380

Vaina de plástico T.E. para pistola telescópica P/5 uds

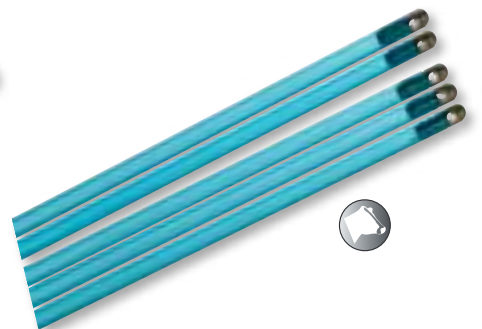

Ref. 026672

Vaina para pistola de 3 mm
P/5 uds



Ref. 017446

Pistola T.E. embrión día 8 equino espiral para pajuela 0,50 mL



Ref. 017532

Vaina no hendida T.E. día 8 equino para pajuela 0,50 mL

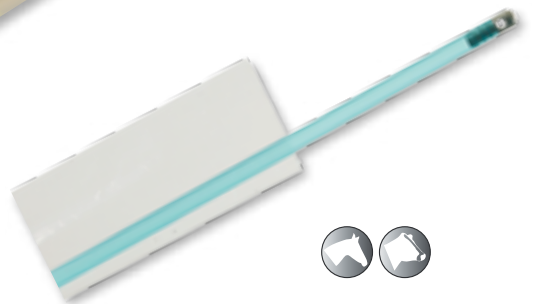

Ref. 006384

Vaina para pistola de 3 mm con camisa sanitaria



Micropipeta estéril T.E. equino P/13 uds

| Día 7 | Día 8 |
|--------|--------|
| 006359 | 018930 |

TRANSFERENCIA DE EMBRIONES

Consumibles T.E.



| Placas estériles | | |
|------------------|------------|-------------|
| 4 pocillos | 6 pocillos | 12 pocillos |
| 020108 | 020107 | 020103 |



Ref. 024605
Cajas Petri 100x100 P/10 uds



| Placas Petri estériles | | |
|------------------------|--------|--------|
| 40 mm | 60 mm | 100 mm |
| 300013 | 300015 | 300017 |



| Pajuela T.E. estéril cristal fina P/5 uds | |
|---|---------|
| L 133 mm | L 91 mm |
| 005592 | 006426 |



| Pajuela T.E. estéril plástico fina P/5 uds | |
|--|---------|
| L 133 mm | L 91 mm |
| 006430 | 006431 |



Ref. 006300
Pajuela fina T.E. amarilla P/5 uds



Ref. 300456
Gel Priority Care 4 l



Ref. 017531
Pajuelas T.E. equino P/2 uds

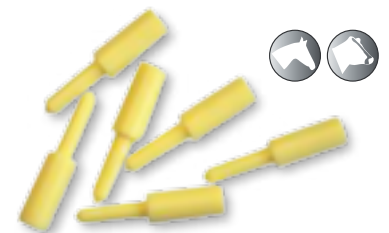

| Junquillo T.E. no estéril P/100 uds | |
|-------------------------------------|--------|
| 13 mm | 48 mm |
| 007352 | 006470 |



Ref. 019665
Gel estéril Priority Care



Ref. 024227
Guante polyactyl estéril
C/100 uds

IMAGO.S



Ref. 90-2273

IMAGO "S" (sectorial)

Equipo ultra portátil y económico, idóneo para trabajo reproductivo en todas las especies ganaderas. Software veterinario específico para cada especie. Actualizaciones de software incluidas.

Funcionamiento con sondas mecánicas, autonomía de 6 horas, maletín de transporte, correas de sujeción, funda de protección, posibilidad de usar con gafas y otros accesorios.



Ref. 90-2250

Sonda sectorial abdominal SB355M

3,5 - 5 MHz, uso abdominal en porcino, ovino y caprino (grasa dorsal y gestación).

Ref. 90-2252

Sonda sectorial rectal DB355M

3,5 - 5 MHz, uso abdominal en porcino, ovino y caprino (grasa dorsal y gestación).
Uso rectal en vacuno (gestación).

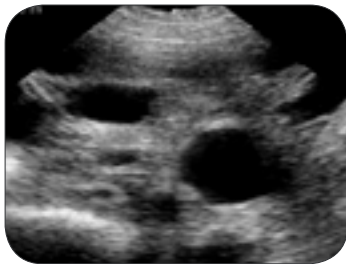

Gestación porcino



Feto cabra 75 días

Accesorios



Ref. 33-1757

Batería IMAGO



Ref. 80-3342

Gafas IMAGO



Ref. 80-2100

Set correas IMAGO



Ref. 22-2597

Parasol IMAGO con gomas



Ref. 22-2598

Parasol IMAGO para funda cuero



Ref. 80-2711

Funda cuero IMAGO

IMAGO



Corpus Luteum

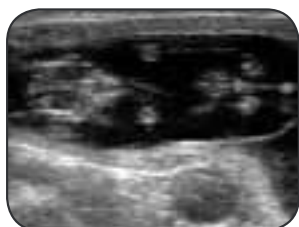

Macho



Ref. 90-1945

IMAGO

Equipo ultra portátil, ideal para trabajos reproductivo y visceral en todas las especies ganaderas. Software veterinario específico para cada especie. Actualizaciones de software incluidas.

Funcionamiento con sondas mecánicas y electrónicas, autonomía de 6 horas, maletín de transporte, correas de sujeción, funda de protección, posibilidad de usar con gafas y otros accesorios.



Ref. 90-2249

Sonda convexa abdominal CB360S
60 mm - 3,5 MHz - 80 elementos



Ref. 90-2248

Sonda lineal abdominal LB740R
40 mm - 7,5 MHz - 80 elementos



Ref. 90-2955

Sonda lineal rectal LB760V
60 mm - 7,5 MHz - 80 elementos



Ref. 90-2250

Sonda sectorial abdominal SB355M
3,5 - 5 MHz, uso abdominal en porcino, ovino y caprino (grasa dorsal y gestación).



Ref. 90-2252

Sonda sectorial rectal DB355M
3,5 - 5 MHz, uso abdominal en porcino, ovino y caprino (grasa dorsal y gestación).
Uso rectal en vacuno (gestación).



EXAGO



Ref. 90-1119

EXAGO

Equipo portátil polivalente, uso reproductivo, visceral y músculo-esquelético en todas las especies. Dispone de doppler color, PW, modo M, guía de biopsia y OPU. Software veterinario específico para cada especie. Actualizaciones de software incluidas.

Autonomía de 7 horas, protector del teclado, maletín de transporte. Pantalla visible desde cualquier ángulo. Posibilidad de incorporar carro de transporte y disparador a distancia.

Especificaciones del sistema

- Peso: 3250 gramos
- Pantalla: 8,4"
- Teclado alfanumérico y touchpad
- Altavoz integrado
- Batería intercambiable
- Larga autonomía
- Uso intuitivo
- Modos de imagen: B, B+B, B+M, color flow mapping, Doppler pulsado, zoom, cine loop
- Conexiones: RJ45, vídeo compuesto, USB, DVI

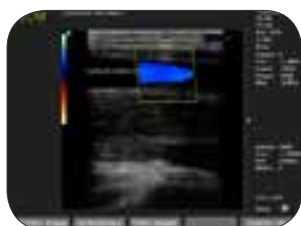

Yugular caballo

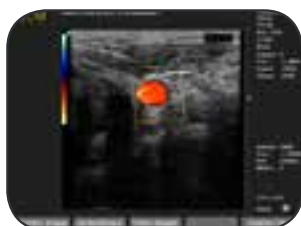

Doppler arteria



Ref. 90-1446

Sonda convexa C360

60 mm - 3,5 MHz - 128 elementos



Ref. 90-1282

Sonda microconvexa C614P

14 mm - 6 MHz - 128 elementos



Ref. 90-1449

Sonda miniconvexa C320A

20 mm - 3,5 MHz - 128 elementos



Ref. 90-2956

Sonda lineal rectal LR760V

60 mm - 7,5 MHz - 128 elementos



Ref. 90-1283

Sonda lineal abdominal L738P

38 mm - 7,5 MHz - 128 elementos



Ref. 10-1668

Gel pad sonda lineal



Ref. 90-3001

Sonda + guía Ovum Pick Up novillas



EXAGO

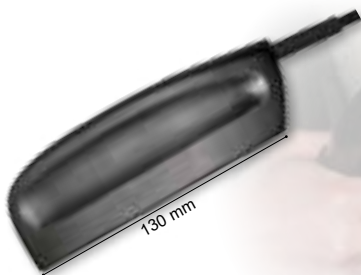

Ref. 90-2253

Sonda lineal abdominal L3130B
130 mm - 3,5 MHz - 128 elementos
(porcino)



Ref. 90-2254

Sonda lineal abdominal L3180B
180 mm - 3,5 MHz - 128 elementos
(vacuno)



Gel pad para sonda lineal abdominal

| Sonda 90-2253 | Sonda 90-2254 |
|---------------|---------------|
| 10-2771 | 10-2770 |



Ref. 15907

Funda EXAGO

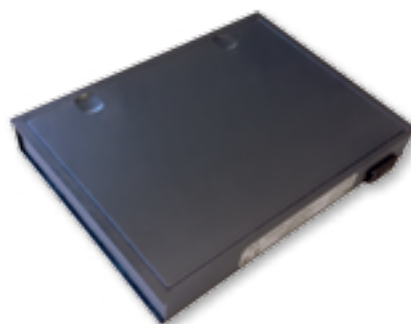

Ref. 33-2316

Batería EXAGO



Ref. 80-2365

Cubierta teclado EXAGO

Software para EXAGO



ECOTEXT



Ref. 222222

ECOTEXT

SOFTWARE DE ANÁLISIS TESTICULAR PARA TODAS LAS ESPECIES.

ECOTEXT analiza las imágenes testiculares, obteniendo parámetros importantes para el funcionamiento testicular que hasta ahora solo se podían obtener mediante biopsia o histología post mortem.

ECOTEXT está configurado para su uso con el ecógrafo EXAGO conectado a una sonda lineal rectal de 7,5 MHz.

ECOTEXT es útil en la predicción de la capacidad reproductiva de los machos jóvenes antes de entrar en un centro y también para evaluar la salud testicular en reproductores valiosos.



BioSoft TOOLBOX II

Ref. 556

BioSoft Toolbox II



SOFTWARE DE ANÁLISIS DE GRASA DORSAL E INTRAMUSCULAR Y TAMAÑO DEL OJO DE LOMO EN PORCINO

BioSoft Toolbox® II para cerdos ofrece a las empresas de cría de cerdos y engorde la herramienta de apoyo por ultrasonidos más completa que se haya desarrollado y comercializado. BioSoft Toolbox® II permite analizar la acumulación de grasa dorsal e intramuscular de sus animales, además del tamaño del ojo de lomo. Esto le permite clasificar sus animales según la calidad de la carne, seguir con precisión la condición corporal de sus hembras y optimizar sus decisiones en la granja.



Biotronics Inc.
Software and Systems Integration for Ultrasound Applications

Líder mundial en el desarrollo de tecnologías de ultrasonido para la industria cárnica.

El equipo de gestión e investigación de Biotronics, Inc. cuenta con más de 60 años de experiencia combinada de investigación y desarrollo en la aplicación de tecnología de ultrasonido para mejorar las características de la calidad de la carne en el ganado porcino.



BIOSOFT Toolbox II

BioSoft Toolbox® II permite analizar la acumulación de grasa dorsal e intramuscular en los animales, además del tamaño del ojo de lomo.

BioQscan Pork Carcass Grading System

Es un sistema totalmente integrado que incluye el sistema de escaneo por ultrasonido, el módulo de procesamiento y la sonda.



El sistema mantiene una base de datos completa que se personaliza para interactuar con otros requisitos de procesamiento de la planta.

ECOTEXT

Software ecográfico para la predicción de la calidad del esperma en las especies porcina, bovina, equina y ovina

Programa informático que estudia el tejido testicular mediante el análisis de imagen de su ecografía



Es un método no invasivo de evaluación del estado testicular y de la calidad seminal en los machos.

Seguimiento del correcto desarrollo testicular de los machos jóvenes hasta su entrada en plena producción.

Selección y descarte temprano de los machos con subfertilidad o infertilidad por problemas en la espermatogénesis.

Ayuda para la selección de machos por sus caracteres reproductivos.

EXAPad^{mini}



Ref. 90-2440KIT

EXAPAD MINI

Equipo portable polivalente, uso reproductivo, visceral y musculoesquelético en todas las especies. Dispone de doppler color, PW, modo cardíaco, guía de biopsia y OPU. Software veterinario específico para cada especie. Actualizaciones de software incluidas. 250 GB de memoria autónoma.

Pantalla táctil y funcionamiento de los comandos por voz, manejo del equipo a distancia por WiFi, impresión directa de informes. Autonomía de 4 horas, maletín de transporte y funda protectora. Posibilidad de incorporar carro de transporte y otros accesorios.



Ref. 90-1446

Sonda convexa C360
60 mm - 3,5 MHz - 128 elementos



Ref. 90-1282

Sonda microconvexa C614P
14 mm - 6 MHz - 128 elementos



Ref. 90-1449

Sonda miniconvexa C320A
20 mm - 3,5 MHz - 128 elementos

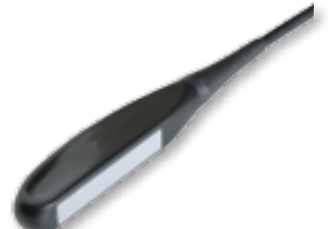

Ref. 90-2956

Sonda lineal rectal LR760V
60 mm - 7,5 MHz - 128 elementos



Ref. 90-3001

Sonda + guía Ovum Pick Up
novillas



Ref. 90-1283

Sonda lineal abdominal L738P
38 mm - 7,5 MHz - 128 elementos



Ref. 10-1668

Gel pad sonda lineal

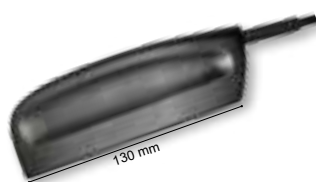

Ref. 90-2253

Sonda lineal abdominal L3130B
130 mm - 3,5 MHz - 128 elementos
(porcino)

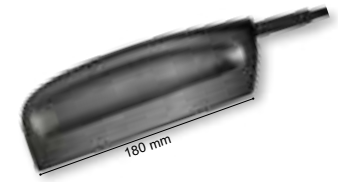

Ref. 90-2254

Sonda lineal abdominal L3180B
180 mm - 3,5 MHz - 128 elementos
(vacuno)



Ref. 90-2922

Carrito EXAPAD



Ref. 90-3075

Carrito EXAPAD ajustable



EXAPad



Ref. 90-3346

EXAPAD

Equipo portable polivalente, uso reproductivo, visceral y músculo-esquelético en todas las especies. Dispone de doppler color, PW, modo cardíaco, guía de biopsia y OPU. Posibilidad de conectar dos sondas a la vez. Software veterinario específico para cada especie. Actualizaciones de software incluidas. 500 GB de memoria autónoma.

Pantalla táctil 15", funcionamiento de los comandos por voz, manejo del equipo a distancia por WiFi, impresión directa de informes. Autonomía de 4 horas, maletín de transporte y funda protectora. Posibilidad de incorporar carro de transporte y otros accesorios.



Ref. 90-3001

Sonda + guía Ovum Pick Up novillas

Gel pad para sonda lineal abdominal

| Sonda L3130B | Sonda L3180B |
|--------------|--------------|
| 10-2771 | 10-2770 |

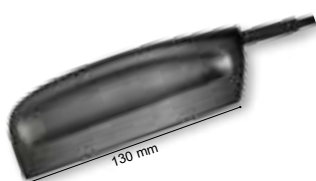

Ref. 90-2253

Sonda lineal abdominal L3130B
130 mm - 3,5 MHz - 128 elementos (porcino)

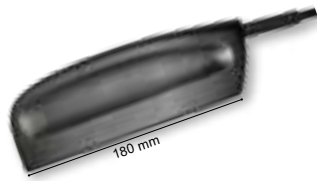

Ref. 90-2254

Sonda lineal abdominal L3180B
180 mm - 3,5 MHz - 128 elementos (vacuno)



Ref. 90-1446

Sonda convexa C360
60 mm - 3,5 MHz - 128 elementos



Ref. 90-1282

Sonda microconvexa C614P
14 mm - 6 MHz - 128 elementos



Ref. 90-1449

Sonda miniconvexa C320A
20 mm - 3,5 MHz - 128 elementos



Ref. 90-2956

Sonda lineal rectal LR760V
60 mm - 7,5 MHz - 128 elementos



Ref. 90-1283

Sonda lineal L738P
38 mm - 7,5 MHz - 192 elementos



Sondas alta densidad EXAPad



Ref. 90-2918

Sonda lineal LC1038V
38 mm - 10 MHz - 192 elementos



Ref. 90-2920

Sonda convexa CC550V
50° - 5 MHz - 192 elementos



Ref. 90-2919

Sonda lineal LC1428V
28 mm - 14 MHz - 192 elementos



Ref. 90-3071

Sonda microconvexa CC717B
17 mm - 7 MHz - 192 elementos

Características ecógrafos



| | iMAGo.S | iMAGo | EXAGo | EXAPad ^{mini} | EXAPad |
|-------------------------------------|--------------------|--------------------------|---------------------------------|------------------------|--------------|
| Peso (kg) | 1,8 | 1,8 | 3,25 | 4 | 5,9 |
| Autonomía | 6 horas | 6 horas | 7 horas | 4 horas | 2 horas |
| Disco duro integrado | - | - | - | 250 GB | 500 GB |
| Bluetooth | ✓ | ✓ | ✓ | ✓ | ✓ |
| Puertos USB | 1 | 1 | 1 | 2 | 4 |
| Conexiones externas | Video RGB | Video RGB | Video RGB/DVI | HDMI/ECG | HDMI/ECG |
| Conexión WiFi | - | - | - | ✓ | ✓ |
| Software veterinario | ✓ | ✓ | ✓ | ✓ | ✓ |
| Canales de Emisión | 16 | 16 | 32 | 64 | 96 |
| Foco Multizona | ✓ | ✓ | ✓ | ✓ | ✓ |
| Actualizaciones | Incluidas | Incluidas | Incluidas | Incluidas | Incluidas |
| Teclado | Táctil Presión | Táctil Presión | Teclado alfanumérico + TouchPad | Táctil | Táctil |
| Pantalla | TFT LCD | TFT LCD | TFT LCD | LCD LED | LCD LED |
| Control por Voz | - | - | - | ✓ | ✓ |
| Tamaño pantalla | 6,5" | 6,5" | 8,4" | 12" | 15" |
| Ajuste luz pantalla | ✓ | ✓ | ✓ | ✓ | ✓ |
| Sonido | - | - | Stereo | Stereo | Stereo |
| Profundidad | 5 Niveles | 6 Niveles | 6 Niveles | 6 Niveles | 6 Niveles |
| Tipos de sonda | Mecánicas | Electrónicas y mecánicas | Electrónicas | Electrónicas | Electrónicas |
| Sondas multifrecuencia | Todas | Todas | Todas | Todas | Todas |
| Sondas Alta densidad | - | - | - | - | ✓ |
| Modo B | ✓ | ✓ | ✓ | ✓ | ✓ |
| Modo Dual | ✓ | ✓ | ✓ | ✓ | ✓ |
| Modo Doppler | - | - | ✓ | ✓ | ✓ |
| Modo PW | - | - | ✓ | ✓ | ✓ |
| Modo M | ✓ | ✓ | ✓ | ✓ | ✓ |
| Cuadrícula en pantalla | ✓ | ✓ | ✓ | - | - |
| Anotaciones | ✓ | ✓ | ✓ | ✓ | ✓ |
| Mediciones en vivo | ✓ | ✓ | ✓ | ✓ | ✓ |
| Medición foliculos automática | ✓ | ✓ | ✓ | ✓ | ✓ |
| Medida grasa automática | ✓ | ✓ | ✓ | - | - |
| Protocolos definidos por el usuario | ✓ | ✓ | ✓ | ✓ | ✓ |
| Tablas de edad de gestación | ✓ | ✓ | ✓ | ✓ | ✓ |
| Informe por paciente | ✓ | ✓ | ✓ | Formato Word | Formato Word |
| Guardado de imágenes | ✓ | ✓ | ✓ | ✓ | ✓ |
| Guardado de video | 2 seg (124 frames) | 3 seg (124 frames) | 3 seg (124 frames) | hasta 40 seg | hasta 40 seg |

Tabla sondas/Accesorios



| | | IMAGOS | IMAGO | EXAGO | EXAPad ^{mini} | EXAPad |
|--|---|--------------|--------------|--------------|------------------------|--------------|
| | Sonda sectorial abdominal (3,5 - 6,0 MHz) | Ref. 90-2250 | Ref. 90-2250 | - | - | - |
| | Sonda sectorial rectal (3,5 - 6,0 MHz) | Ref. 90-2252 | Ref. 90-2252 | - | - | - |
| | Sonda convexa (2,5 - 5,0 MHz) | - | Ref. 90-2249 | Ref. 90-1446 | Ref. 90-1446 | Ref. 90-1446 |
| | Sonda miniconvexa (2,5 - 5,0 MHz) | - | - | Ref. 90-1149 | Ref. 90-1149 | Ref. 90-1149 |
| | Sonda microconvexa (5,0 - 7,5 MHz) | - | - | Ref. 90-1282 | Ref. 90-1282 | Ref. 90-1282 |
| | Sonda lineal T (5,0 - 7,5 MHz) | - | Ref. 90-2248 | Ref. 90-1283 | Ref. 90-1283 | Ref. 90-1283 |
| | Sonda lineal rectal (5,0 - 7,5 MHz) | - | Ref. 90-2955 | Ref. 90-2956 | Ref. 90-2956 | Ref. 90-2956 |
| | Sonda OPU (5,0 - 7,5 MHz) | - | - | Ref. 90-3001 | Ref. 90-3001 | Ref. 90-3001 |
| | Sonda lineal larga 130 mm (2,5 - 5,0 MHz) | - | - | Ref. 90-2253 | Ref. 90-2253 | Ref. 90-2253 |
| | Sonda lineal larga 180 mm (2,5 - 5,0 MHz) | - | - | Ref. 90-2254 | Ref. 90-2254 | Ref. 90-2254 |
| | Sonda convexa alta densidad (3,5 - 6,0 MHz) | - | - | - | - | Ref. 90-2920 |
| | Sonda microconvexa alta densidad (5,0 - 9,0 MHz) | - | - | - | - | Ref. 90-3071 |
| | Sonda lineal T alta densidad 38 mm (7,5 - 15,0 MHz) | - | - | - | - | Ref. 90-2918 |
| | Sonda lineal T alta densidad 28 mm (7,5 - 15,0 MHz) | - | - | - | - | Ref. 90-2919 |



| Gel pad sonda lineal abdominal | |
|--------------------------------|--------------|
| Sonda L3130B | Sonda L3180B |
| 10-2771 | 10-2770 |



Ref. 10-1668
Gel pad sonda lineal



Ref. 6410326
Gel ecógrafo 5 litros



Ref. 024259
Funda protectora sonda C/500 uds

easi-scan™



Ref. E4-Scanner-D
Easi-Scan lineal



Ref. E4-Scanner-C
Easi-Scan curve

Ecógrafo portátil para detección de gestaciones en ganado bovino y equino. Muy ligero y versátil, con una autonomía de 4 horas de trabajo, tiene dos configuraciones de sonda diferentes: La sonda lineal rectal, para diagnósticos precisos y detallados de la gestación temprana y sexaje, y la sonda lineal curva, que nos ofrece mayor amplitud de imagen facilitando la localización de los fetos dándonos una gran rapidez de trabajo en gestaciones tempranas y tardías.

Tiene la opción de trabajar con las gafas (BUG) o una pantalla externa.



Preñez día 37
modo 8 cm



Cotiledones
modo 24 cm



Músculo esqueléticas

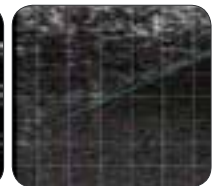

Grasa dorsal



Ovi-Scan



Ref. Ovi6-duo3
Ovi-Scan



Equipo portable para diagnóstico de gestación en ovino.

La cubierta del Ovi-Scan está diseñada para trabajar en condiciones extremas, nos permite clasificar a los animales entre preñados y no preñados, además la calidad de la imagen nos permite visualizar en la pantalla el número de fetos y la edad de gestación.

Dispone de una sonda mecánica específica que nos permite realizar todo el trabajo rápido y cómodamente.



Ref. Ovi6-S

Sonda abdominal axial

Sonda mecánica multifrecuencia que alcanza hasta 28 cm de profundidad, su disposición axial nos permite un buen contacto con el abdomen y una vista única de 170° facilitando la detección de las gestaciones.

Easi-Scan:Go[®]



BCF Go Scan App

La aplicación ecográfica BCF Go Scan le permite visualizar en su dispositivo móvil la imagen obtenida con el equipo Easi-Scan Go. La conexión es muy sencilla a través de WiFi.

En la aplicación dispone de múltiples opciones de configuración de la imagen, así como la posibilidad de poner una cuadrícula para mediciones y determinar la edad de gestación de los fetos.

El manejo de la aplicación es muy intuitivo y sencillo, todos los botones y las opciones de configuración están referenciados por un símbolo para facilitar su comprensión y manejo.

Gracias a estar utilizando un dispositivo móvil, podemos guardar y compartir todo nuestro trabajo y llevárnoslo con nosotros sin necesidad de realizar ningún postproceso.

Ref. ESG-Scanner-L
Easi-Scan:Go lineal

Ref. ESG-Scanner-C
Easi-Scan:Go curve

Ecógrafo portátil ultraligero para diagnóstico de gestación en ganado bovino y equino.

Tiene dos configuraciones de sonda diferentes: La sonda lineal rectal, para diagnósticos precisos y detallados de la gestación temprana y sexaje, y la sonda lineal curva, que nos ofrece mayor amplitud de imagen facilitando la localización de los fetos dándonos una gran rapidez de trabajo en gestaciones tempranas y tardías.

El equipo de 850 g de peso transmite a través de WiFi la imagen ecográfica hasta a 3 dispositivos diferentes iOS o Android. Así, podemos evaluar los animales desde nuestro teléfono móvil o una tablet, solo hay que descargarse la aplicación de Internet.

El ecógrafo Easi-Scan Go dispone de diferentes accesorios para sujetar la pantalla, de este modo el usuario puede elegir el método de visión: gafas, pantalla o visor de muñeca.

Resistente al agua y con cinco horas de autonomía, permite clasificar los animales entre gestantes y no gestantes, realizar mediciones de los fetos para determinar la edad de gestación, medir los folículos de sus hembras y guardar toda la información en su teléfono móvil.

Al trabajar con dispositivos externos con memoria propia, el Easi-Scan Go le permite almacenar vídeos y todas las imágenes que desee en un formato universal que puede compartir con el ganadero o veterinario.



Requisitos mínimos SmartPhones

ANDROID

- S.O: Kit Kat (Android V4.4)
- Memoria: 1.5 GB
- Procesador: Quad-Core 1.2 GHz
- WIFI recomendado: 802.11 a/ac (banda 5GHz)

APPLE

- Versión iOS 8
- iPhone 5s
- iPad4



Ref. ESG-CHARGER
Cargador Easi-Scan:Go



Ref. ESG-BATT
Batería Easi-Scan:Go



Ref. ESG-BUG
Gafas WIFI

Duo-Scan:Go[®]



Ecógrafo portátil ultraligero para diagnóstico de gestación en porcino, ovino y caprino.

El equipo se compone de una sonda inalámbrica que emite señal WiFi. De este modo el usuario puede elegir el método de visión: gafas, pantalla o visor de muñeca utilizando el propio teléfono móvil o una tablet. Solo hay que descargarse la aplicación de Internet. Se pueden conectar 3 equipos a la vez.

Resistente al agua y con dos horas de autonomía, permite clasificar los animales entre gestantes y no gestantes.



Ref. DSG-SCANNER-C
Duo-Scan:Go 32 elementos



Ref. DSG-SCANNER-CP
Duo-Scan:Go 64 elementos



Accesorios



Ref. BUG-E3
Gafas Bug



Ref. E3-Remote-Display
Pantalla remota Easi-Scan



Ref. ACC-Wrist-Mount-Kit
Visor de muñeca



Ref. EASI-CASE
Smart Display Easi-Scan



Ref. E3-BAG
Bolsa transporte Easi-Scan



Ref. E3-CARRY-CASE
Maletín cargador Easi-Scan

Características ecógrafos



| | Ovi-Scan | easi-scan | easi-scan LIVINE | Duo-Scan:Go | Easi-Scan:Go | Easi-Scan:Go curve |
|------------------------------------|-------------------|----------------------------------|--------------------------|-------------------------|----------------------------|--------------------------|
| Peso (kg) | 5 kg | 2 kg | | 246 g | 850 g | |
| Autonomía | - | 4 horas | | 2 horas | 5 horas | |
| Cargador | Con cable | Con cable/cargador coche | | Wireless | Wireless | |
| Resistente al agua | - | ✓ | | ✓ | ✓ | |
| Disco duro integrado | - | 100 imágenes | | Memoria Teléfono/Tablet | Memoria Teléfono/Tablet | |
| USB | - | Adaptador USB | | - | - | |
| Salida de Video | - | Sí, con Smart Display Device | | - | - | |
| Conexión WiFi | - | - | | ✓ | ✓ | |
| Software veterinario | ✓ | 4 modos de trabajo | | ✓ | ✓ | |
| Canales digitales | 1 | 16 | | 16 | 16 | |
| Actualizaciones | - | ✓ | | ✓ | ✓ | |
| Teclado | 5 botones | 4 botones key pad | | 1 botón multifunción | 3 botones multifunción | |
| Pantalla | 6,5" | Gafas/Visor de muñeca/Pantalla | | Teléfono móvil/Tablet | Teléfono móvil/Tablet | |
| Conexión varias pantallas a la vez | - | - | | 3 dispositivos | 3 dispositivos | |
| Tipos de sonda | Mecánica | Lineal Rectal | Curva Rectal/Abdominal | Curva abdominal | Lineal Rectal | Curva Rectal/Abdominal |
| Profundidad | 3 cm - 32 cm | 6 cm - 12 cm | 6 cm - 24 cm | 6 cm - 24 cm | 6 cm - 12 cm | 6 cm - 24 cm |
| Características sonda | 170° curvatura | 128 elementos, 64 mm | 128 elementos, 60 mm 60° | 32/64 elementos | 128 elementos | 128 elementos, 60 mm 60° |
| Sonda multifrecuencia | 2,5 MHz - 7,5 MHz | 4,5 MHz - 8,5 MHz | 3 MHz - 7MHz | 3MHz - 6 MHz | 4,5 MHz - 8,5 MHz | 3 MHz - 7MHz |
| Frame Rate | 12 frames/seg | 26 frames/seg | | 25 frames/seg | 30 frames/seg | |
| Cuadrícula en pantalla | - | ✓ | | ✓ | ✓ | |
| Anotaciones | - | ✓ | | ✓ | ✓ | |
| Mediciones | - | ✓ | | ✓ | ✓ | |
| Medida grasa automática | - | ✓ (sonda lineal + Smart Display) | | ✓ | ✓ (solamente sonda lineal) | |
| Tablas de edad de gestación | ✓ | ✓ | | - | ✓ | |
| Guardado por paciente | - | ✓ | | ✓ | ✓ | |
| Guardado de imágenes | - | ✓ | | ✓ | ✓ | |
| Guardado de video | - | ✓ | | ✓ | ✓ | |

Endoscopios fijos y portátiles

TORRE DE ENDOSCOPIA

Equipo fijo y polivalente que permite realizar exámenes cotidianos, desde la otoscopia a otros más complejos como endoscopias respiratorias y digestivas. Es el equipo ideal para la práctica de cualquier tipo de endoscopia en la clínica.



Ref. 1COL-COMP

DAILYSCOPE

Permite conectar todo tipo de vídeo-endoscopios. Todo en uno: ordenador con pantalla táctil y conexiones WiFi y Ethernet que puede colocar en un carro, mesa o mueble. Software de adquisición y archivo de imágenes y videos SYCRE.



Ref. DSCOPE

DUO PACK

Es un equipo muy fácil de usar para toda la endoscopia rígida (otoscopia, rinoscopia...), así como para la broncoscopia.



Ref. MC165900

RINOSCOPIO

Equipo diseñado para la rinoscopia, también se utiliza para la exploración de cualquier cavidad.



Ref. 3KITRHINO

ACCESORIOS



Pinza de biopsia copa ovalada



Fórceps cuerpos extraños



Cistoscopio



Kit artroscopia



Interruptor pie doble



Otoscopio



Kit laparoscopia

EQUIPOS

Endoscopios dinámicos

DRS® Endoscopia Respiratoria Dinámica

Vídeoendoscopio para realizar endoscopias respiratorias durante el ejercicio y entrenamiento en caballos. Ha sido diseñado para lograr un diagnóstico de precisión de las afecciones respiratorias altas en el caballo, que originan disminución del rendimiento del caballo y/o sonidos respiratorios durante el esfuerzo.

DRS® es un sistema rápido y fácil de colocar en el caballo, y no afecta ni al caballo ni al jinete. El sistema transmisor remoto permite visualizar en tiempo real el examen en una pantalla receptora, mientras se verifica la correcta posición del endoscopio en las vías aéreas. Un sistema automático de lavado limpia las lentes del endoscopio para evitar que el moco o materia orgánica obstruya las lentes.

Ref. FF300010



PE Scope

Equipo diseñado para optimizar su facilidad de uso en campo. Siempre a mano, cómodo de llevar, con gran autonomía, el vídeoendoscopio digital se utiliza en cualquier circunstancia.



Ref. FI603501

VET CASE

Es un equipo portátil de endoscopia que permite conectar vídeoendoscopios de 1,4 a 3,2 m de longitud para efectuar el examen de las vías respiratorias y digestivas.



Ref. 1VALSTANDR

VIDEOENDOSCOPIO

Diferentes modelos de longitud y diámetro de canal.



FIBROSCOPIO BRONQUIAL FB70

Para explorar el aparato respiratorio y el tracto urinario con una calidad óptica excepcional en un pequeño diámetro.

Longitud: 70 cm Diámetro: 3,9 mm

Diámetro canal: 1,4 mm



Ref. FI302200



SISTEMAS MEDRIA PARA EL CONTROL TELEFÓNICO E INFORMÁTICO DE LOS PARTOS, CELOS Y ESTADO SANITARIO EN VACUNO

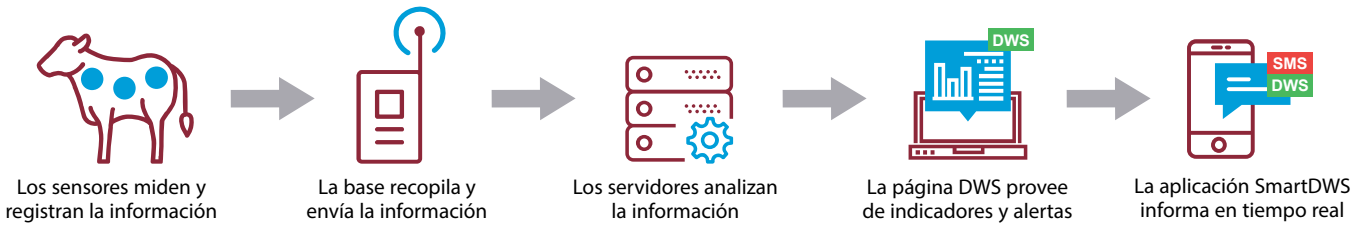

Vel'Phone®

CONTROL DEL PARTO

El sistema le envía un SMS cuando comienza el parto en una novilla o vaca, lo que le permite:

- Reducir el tiempo destinado a vigilar los animales
- Identificar perfectamente al animal que está a punto de parir
- Reducir las complicaciones antes, durante y tras el parto, tanto de las madres como de los terneros

HeatPhone®

CONTROL DEL CELO

El sistema permite monitorizar la salida en celo de los animales a través de mensajes SMS y un programa de gestión online:

- Tendrá un control individualizado de los ciclos reproductivos de vacas y novillas
- Reducirá el intervalo entre partos
- Podrá acceder desde cualquier ordenador con acceso a internet a los datos, gráficas y alarmas reproductivas de los animales

San'Phone®

CONTROL DE LA TEMPERATURA

Cuando un animal tenga una temperatura anormal el sistema le enviará un SMS de alarma. A través del acceso WEB tendrá acceso además al histórico de temperaturas de cada uno de ellos:

- Podrá detectar los trastornos de salud con antelación y mejorar el control y trazabilidad sanitaria de los animales

FeedPhone®

CONTROL DE TRASTORNOS ALIMENTARIOS

Para optimizar la alimentación del rebaño, supervisar las transiciones alimentarias y mantener las condiciones de producción óptimas, Medria ha diseñado una solución innovadora. El FeedPhone proporciona indicadores diarios de ingesta y rumia, y permite la detección precoz de trastornos de alimentación y salud.



La base GSM (base azul) funciona con una tarjeta SIM, a través de la cual se envían los datos a los servidores para generar las informaciones y alertas. La base debe estar colocada a una altura entre 1,5 y 2 m del suelo.

- Funciona con tarjeta SIM
- Distancia captores Vel'Phone < 200 m
- Distancia captores Heat'Phone < 200 m
- Hasta 250 captores
- Con cuota mensual



Ref. ART0200
Base radio GSM



La base Internet (base roja) precisa de una conexión a Internet para enviar los datos a los servidores y generar las informaciones y alertas. Puede conectarse directamente por cable de Ethernet, por PCL o por WIFI. La base debe estar colocada a una altura mayor de 5 m del suelo.

- Sin tarjeta SIM
- Distancia captores Vel'Phone < 200 m
- Distancia captores Heat'Phone < 1000 m
- Hasta 3000 captores
- Sin cuota mensual



Ref. RART1000
Base radio Internet

Accesorios monitorización



Vel'Phone FeedPhone



Ref. ART0300
Dispositivo AXEL GSM



Ref. RART0300
Dispositivo AXEL Internet



Ref. ART0328
Collar dispositivo AXEL 120 cm

HeatPhone



Ref. ART0225
Termómetro vaginal
Base GSM

Ref. RART0225
Termómetro vaginal
Base Internet

(los termómetros se suministran con un lote de apéndices)

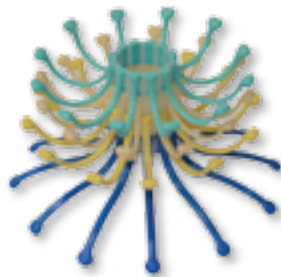

Ref. ART0249
Lote 5 apéndices
termómetro vaginal



Ref. ART0230
Aplicador dispositivo vaginal

San'Phone



| Termobollos | | |
|-------------|------------|----------|
| | Vaca carne | Terneros |
| Base azul | ART0401 | ART0403 |
| Base roja | RART0401 | RART0403 |



| Aplicador termobollos | |
|-----------------------|---------|
| Grande | Pequeño |
| ART0490 | ART0491 |



Accesorios Base GSM



Ref. ART0157
Antena amplificadora
de señal



Ref. ART0156
Mini Box



Ref. ART0234
Buscador manual de dispositivos

Accesorios Base Internet



Ref. RART1401
Kit puente WIFI



Ref. RART1400
Kit puente CPL

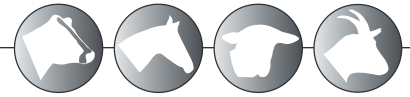

SISTEMA DIGITANIMAL PARA LA LOCALIZACIÓN Y MONITORIZACIÓN DEL GANADO



Cada vaca, cabra, oveja o caballo estará equipado con un collar IoT que monitoriza la localización y el estado del animal. El dispositivo transmite la información a través de una red segura a tu ordenador, tablet o smartphone. Los TAG se comunican con el collar IoT aportando información de proximidad.



- Características del collar IoT:**
- Sistema seguro, robusto y ergonómico
 - Dimensiones: 106x77x50 milímetros
 - Peso dispositivo: 265 gramos
 - Peso contrapeso: 495 gramos
 - Peso conjunto menor a 1 kg
 - Certificado CE
 - Estanqueidad IP67
 - 1 año de duración de batería



- Características del TAG (crotal electrónico):**
- El TAG se comunica a través del dispositivo principal creando una red capaz de monitorizar todo el rebaño:
- Sistema seguro, robusto y ligero
 - Dimensiones: 65x38x14 milímetros
 - Peso dispositivo: 25 gramos
 - 8 meses de duración de batería



Ref. 099901

Digitanimal collar 150 cm



Ref. 099902

Digitanimal collar 85 cm

Beneficios uso digitanimal:



(*) El sistema requiere para su funcionamiento de una cuota anual. La suscripción anual incluye una batería gratis.

JORNADA INTERNACIONAL CIENTÍFICO-TÉCNICA DE REPRODUCCIÓN ANIMAL

Cada año presentamos las últimas tecnologías, novedades y técnicas del sector veterinario y ganadero en el sector de la reproducción animal.

Contamos con ponentes de primer nivel, investigadores y representantes del ámbito veterinario y ganadero en el ámbito de la genética y la reproducción animal.

Alternativamente se dedican a a la reproducción porcina y a la reproducción bovina.

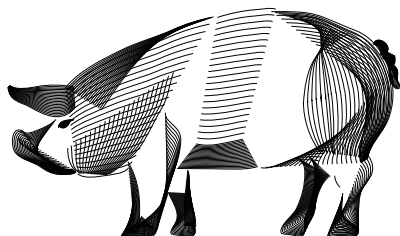
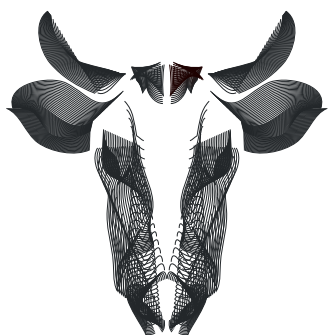

Extracción de sangre



Tubo extracción sangre plástico silicona

| | |
|--------|--------|
| 4,5 mL | 9 mL |
| 150601 | 150603 |



Tubo extracción sangre plástico heparina

| | |
|--------|--------|
| 4,5 mL | 9 mL |
| 150605 | 150607 |



Tubo extracción sangre plástico EDTA

| | |
|--------|--------|
| 4,5 mL | 9 mL |
| 150609 | 150611 |



Ref. 1502016

Tubo genotipado aditivo ADN 5 mL P/50 uds



Aguja VACUETTE

| | |
|----------|----------|
| 1,2 x 25 | 1,2 x 38 |
| 150613 | 150615 |



Aguja VACUETTE multi-sample

| | | |
|--------|--------|--------|
| 1,2x25 | 0,9x25 | 0,9x38 |
| 150620 | 150621 | 150622 |

VACUETTE



Ref. 150623

Porta-tubos Vacuette

Control de temperatura



Ref. 150201

Termómetro digital



Ref. 150203

Termómetro digital instantáneo



Ref. 350205

Termómetro con protector



Ref. 150213

Termómetro líquidos -10°/+100°



Ref. 150211

Termómetro infrarrojos



Ref. 150231

Termómetro digital con sonda

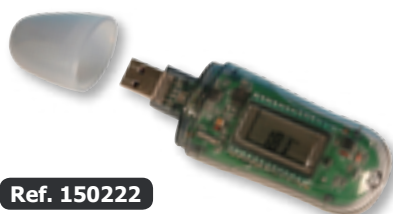

Ref. 150222

Registrador temperatura USB



Ref. 150221

Registrador temperaturas Tinytag Ultra 2

La serie de dataloggers de temperatura de alta precisión TinyTag Ultra 2 son ideales para las aplicaciones en las que el control de temperatura es muy crítico y se requiere una elevada precisión y fiabilidad. Software de fácil utilización. Intervalo de medición. Programable desde 1 segundo hasta 10 días.

150223
Batería
Tinytag

Auscultación/Otoscopia

150016
Bombilla
Otoscopio
GOWLLANDS



Ref. 150015
Otoscopio - Oftalmoscopio
GOWLLANDS

150022
Bombilla
Halógena



Ref. 150021
Otoscopio GOWLLANDS
halógeno

150026
Bombilla
Halógena



Ref. 150025
Otoscopio - Oftalmoscopio
GOWLLANDS halógeno completo



Ref. 150005
Fonendoscopio 3M
LITTMANN classic II 71 cm



Ref. 150001
Fonendoscopio económico



Ref. 150061
Refractómetro para orina

Ref. 150063
Refractómetro para proteína

Espéculos vaginales



Ref. 007180
Espéculo IMV sin luz



Ref. 150035
Espéculo PLEXI con luz
40x300 mm



| Espéculo KILLIAN | |
|------------------|--------|
| 6 cm | 8,5 cm |
| 150029 | 150031 |



Ref. 007799
Espéculo aves



| Espéculo vaginal | |
|------------------|--------|
| 20,3 cm ovejas | 150043 |
| 27 cm yegua/vaca | 150045 |
| 35 cm yegua/vaca | 150047 |

Reactivos



Ref. 150411
Tira reactiva PH C/100 uds



Ref. 150413
Tira reactiva Peróxido 100 C/100 uds



Ref. 151021
Solución tampón PH 4



Ref. 151022
Solución tampón PH 7



Ref. 150431
Tira orina MAKROMED v-10 KRUUSE C/100 uds



Ref. 290837
Tira acetona C/50 uds



Ref. 150417
Pooltester



| Recambio Pooltester P/250 uds | |
|-------------------------------|--------|
| Cloro | PH |
| 150419 | 150421 |



Ref. 150051
Digestor Trichomatic 50/100



Ref. 150445
Placas con medio de cultivo MANNITOL SALT AGAR 6 uds



Ref. 150441
Placas con medio de cultivo MULLER HINTON AGAR 6 uds



Ref. 151020
PHmetro de mano Waterproof



Ref. 150443
Placas con medio de cultivo SABARAUD AGAR 6 uds

Recogida y toma de muestras



| Bote Duquesa con obturador | | | | | |
|----------------------------|--------|--------|--------|--------|---------|
| Presentación | 60 mL | 125 mL | 250 mL | 500 mL | 1000 mL |
| Sin envasado | 150811 | 150813 | 150815 | 150817 | 150819 |
| Envasado unitario | | 150820 | 150821 | 150822 | 150823 |



| Bote muestras estéril | |
|-----------------------|--------|
| 60 mL | 125 mL |
| 150825 | 150827 |



Ref. 150831
Bote muestras leche 30 mL



Ref. 150871
Pipeta plástico PASTEUR 1 mL P/500 uds



Ref. 150873
Pipeta cristal PASTEUR 1 mL P/250 uds

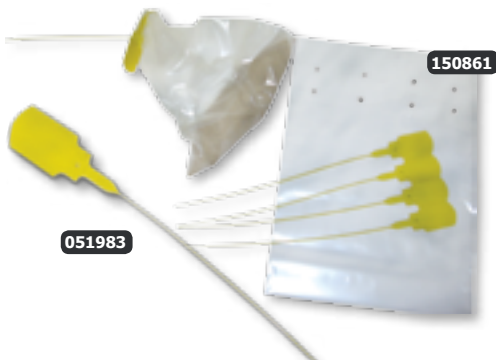

051983

150861

| Bolsa recogida muestras | |
|-------------------------|---------------------|
| Bolsa recogida P/100 | Precintos amarillos |
| 150861 | 051983 |



Ref. 700611
Calza toma de muestras



| Hisopo estéril | | |
|----------------|-----------|------------------|
| Con Amies | Sin medio | Con Amies/Carbón |
| 150841 | 150843 | 150845 |



Ref. 150849
Escobillón 15 cm P/100 uds

Accesorios



| Frasco lavador | |
|----------------|---------|
| 500 mL | 1 litro |
| 151095 | 151096 |

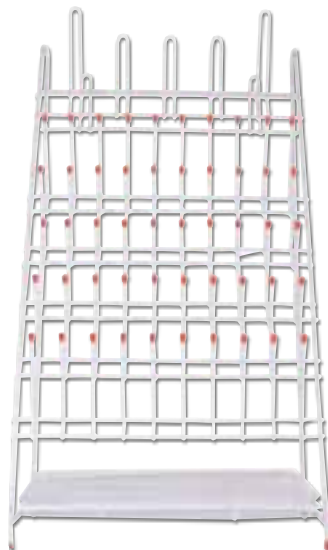

Ref. 151051
Escurreidor en acero inoxidable 55 terminales



151117

151115

151111

151113

| Escobillón limpieza | |
|----------------------|--------|
| Bureta-pipetas | 151111 |
| Tubo de ensayo | 151113 |
| Botella pequeña | 151115 |
| Botella grande | 151117 |
| Pipeta y embudos | 151119 |
| Pipeta y volumétrica | 151121 |



Ref. 151141
Papel parafilm 100x38



Ref. 151101
Jabón laboratorio PH neutro 5 litros

MATERIAL QUIRÚRGICO

Pinzas



| Pinza mosquito recta | | |
|----------------------|-----------|-----------|
| Medida | Calidad A | Calidad B |
| 12,5 cm | 200273 | 200271 |



| Pinza Kocher recta con dientes | | |
|--------------------------------|-----------|-----------|
| Medida | Calidad A | Calidad B |
| 16 cm | 200249 | 200251 |



| Pinza mosquito recta con dientes | | |
|----------------------------------|-----------|-----------|
| Medida | Calidad A | Calidad B |
| 13 cm | 200279 | 200280 |



| Pinza mosquito curva | | |
|----------------------|-----------|-----------|
| Medida | Calidad A | Calidad B |
| 12,5 cm | 200277 | 200275 |



| Pinza Kocher curva con dientes | | |
|--------------------------------|-----------|-----------|
| Medida | Calidad A | Calidad B |
| 16 cm | 200253 | 200255 |



| Pinza mosquito curva con dientes | | |
|----------------------------------|-----------|-----------|
| Medida | Calidad A | Calidad B |
| 13 cm | 200281 | 200282 |



| Pinza intestinal Babcock | | |
|--------------------------|-----------|-----------|
| Medida | Calidad A | Calidad B |
| 16 cm | 200285 | 200286 |



| Pinza intestinal Doyen recta | | |
|------------------------------|-----------|-----------|
| Medida | Calidad A | Calidad B |
| 23 cm | 200289 | 200287 |



| Pinza Rochester recta | | |
|-----------------------|-----------|-----------|
| Medida | Calidad A | Calidad B |
| 14 cm | 200225 | 200231 |
| 16 cm | 200227 | 200233 |
| 18 cm | 200229 | 200235 |



Ref. 200283
Pinza intestinal Allis 15 cm



| Pinza intestinal Doyen curva | | |
|------------------------------|-----------|-----------|
| Medida | Calidad A | Calidad B |
| 23 cm | 200293 | 200291 |



| Pinza Rochester curva | | |
|-----------------------|-----------|-----------|
| Medida | Calidad A | Calidad B |
| 14 cm | 200237 | 200243 |
| 16 cm | 200239 | 200245 |
| 18 cm | 200241 | 200247 |



| Pinza hemostática Pean | |
|------------------------|-------------|
| Recta 14 cm | Curva 14 cm |
| 200221 | 200223 |



| Pinza compresora Foerster oval | | |
|--------------------------------|--------|--------|
| Medida | Recta | Curva |
| 24 cm | 200305 | 200306 |



| Pinza para campo Backhaus | |
|---------------------------|--------|
| 9 cm | 13 cm |
| 200319 | 200321 |

Pinzas



Ref. 200209
Separador Weitlaner 14 cm



Ref. 200217
Separador de Gelpi 17 cm



Ref. 200205
Separador abdominal Weingart



Ref. 200211
Separador Senn-Miller 15 cm



Ref. 141980
Pinza Equivet cuello uterino

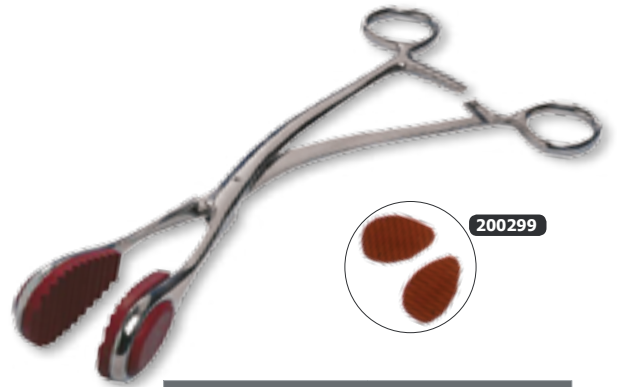

Pinza uterina cabeza goma 28 cm

| Pinza | Gomas recambio |
|--------|----------------|
| 200295 | 200299 |



Ref. 141965
Pinza biopsia Equivet



Ref. 200201
Pinza Blendinger para panza 20 cm



| Pinza uterina Museux recta | | |
|----------------------------|-----------|-----------|
| Medida | Calidad A | Calidad B |
| 24 cm | 200301 | 200303 |



| Pinza cuerpos extraños Hartman | | |
|--------------------------------|-----------|-----------|
| Medida | Calidad A | Calidad B |
| 14 cm | 200315 | 200317 |

MATERIAL QUIRÚRGICO

Pinzas



Ref. 200327

Pinza anatómica recta
13 cm estándar



Ref. 200329

Pinza anatómica curva
13 cm estándar



Ref. 200325

Pinza disección recta con
dientes 13 cm estándar



Pinza Adson con diente

| Medida | Calidad A | Calidad B |
|--------|-----------|-----------|
| 12 cm | 200341 | 200342 |



Pinza Adson sin diente

| Medida | Calidad A | Calidad B |
|--------|-----------|-----------|
| 12 cm | 200343 | 200344 |



Pinza anatómica estándar

| 15 cm | 18 cm |
|--------|--------|
| 200335 | 200337 |



Pinza quirúrgica estándar

| 15 cm | 18 cm |
|--------|--------|
| 200331 | 200333 |



Jørgen Kruuse A/S
Havretøften 4
DK-5550 Langeskov - Denmark
Tel.: +45 72 14 15 16
Fax: +45 72 14 15 00
export@kruuse.com - www.kruuse.com



Ref. 200323

Pinza para campo Jones



Tijera Lister

| Medida | Calidad A | Calidad B |
|--------|-----------|-----------|
| 18 cm | 200073 | 200071 |



Ref. 200075

Tijera universal multicorte 19 cm

Tijeras



| Tijera recta punta R/R | | |
|------------------------|-----------|-----------|
| Medida | Calidad A | Calidad B |
| 14 cm | 200019 | 200001 |
| 16 cm | 200025 | 200007 |
| 18 cm | | 200013 |



| Tijera recta punta R/A | | |
|------------------------|-----------|-----------|
| Medida | Calidad A | Calidad B |
| 14 cm | 200021 | 200003 |
| 16 cm | 200027 | 200009 |
| 18 cm | | 200015 |



| Tijera recta punta A/A | | |
|------------------------|-----------|-----------|
| Medida | Calidad A | Calidad B |
| 14 cm | 200023 | 200005 |
| 16 cm | 200029 | 200011 |
| 18 cm | | 200017 |



| Tijera curva punta R/R | | |
|------------------------|-----------|-----------|
| Medida | Calidad A | Calidad B |
| 14 cm | 200041 | 200031 |
| 16 cm | 200047 | |



| Tijera curva punta R/A | | |
|------------------------|-----------|-----------|
| Medida | Calidad A | Calidad B |
| 14 cm | 200043 | 200033 |
| 16 cm | 200049 | 200037 |



| Tijera curva punta A/A | | |
|------------------------|-----------|-----------|
| Medida | Calidad A | Calidad B |
| 14 cm | 200045 | 200035 |



| Tijera disección Metzenbaun | | |
|-----------------------------|-----------|-----------|
| Medida | Calidad A | Calidad B |
| 15 cm | 200053 | 200057 |
| 18 cm | 200055 | 200059 |



| Tijera Mayo recta 17 cm | |
|-------------------------|-----------|
| Calidad A | Calidad B |
| 200061 | 200063 |

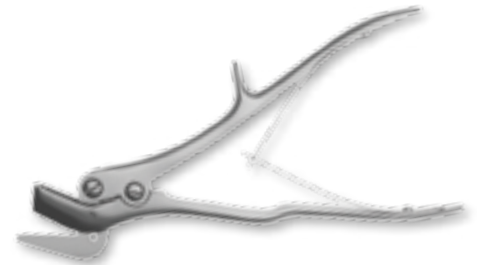

Ref. 200091

Tijera dentada escayola
calidad A 8 cm



Ref. 200079

Tijera Iris recta 12 cm calidad A



Ref. 200089

Tijera sutura recta dentada 12 cm



Ref. 200083

Tijera sutura Spencer
curva 12 cm



Ref. 200081

Tijera Iris curva 12 cm calidad A



Ref. 200085

Tijera sutura curva dentada 12 cm

MATERIAL QUIRÚRGICO

Porta-agujas



| Porta-agujas Mathieu | | | |
|----------------------|-----------|-----------|-----------|
| Medida | Calidad A | Calidad B | Tungsteno |
| 14 cm | 200773 | | 200776 |
| 17 cm | 200774 | 200771 | 200777 |
| 20 cm | 200775 | 200772 | 200778 |



Ref. 200779

Porta-agujas Hegar Olsen
14 cm calidad A

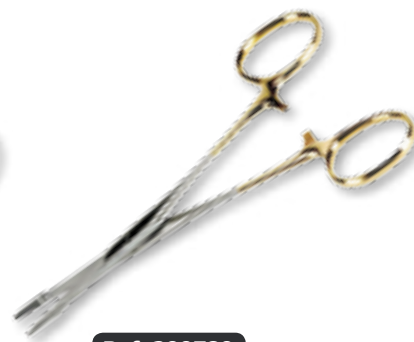

Ref. 200780

Porta-agujas Hegar Olsen
14 cm tungsteno

Agujas de sutura

P/10 uds

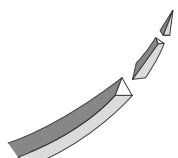

| Circular 3/8, punta triangular invertida | | |
|--|---------------|---------------|
| Ojo regular | Longitud (mm) | Ojo de muelle |
| 152600 | 17 mm | 152630 |
| 152601 | 21 mm | 152631 |
| 152602 | 25 mm | 152632 |
| 152603 | 29 mm | 152633 |
| 152604 | 41 mm | 152634 |
| | 45 mm | 152635 |
| 152605 | 49 mm | 152636 |
| 152606 | 61 mm | 152637 |
| 152607 | 89 mm ø1,1 | 152638 |
| 152608 | 89 mm ø1,6 | |



| Circular 1/2, punta triangular invertida | | |
|--|---------------|---------------|
| Ojo regular | Longitud (mm) | Ojo de muelle |
| | 29 mm | 152646 |
| 152620 | 41 mm | 152647 |
| 152621 | 49 mm | |
| 152622 | 69 mm | 152648 |

6.5 mm

13 mm

16 mm

19 mm

22 mm

24 mm

26 mm

30 mm

36 mm

40 mm

48 mm

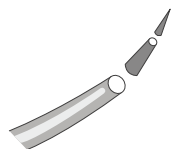

| Circular 3/8, cuerpo redondo | | |
|------------------------------|---------------|---------------|
| Ojo regular | Longitud (mm) | Ojo de muelle |
| | 18 mm | 152640 |
| | 23 mm | 152641 |
| 152625 | 28 mm | 152642 |

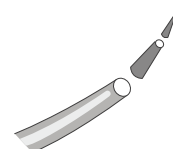

| Circular 1/2, cuerpo redondo | | |
|------------------------------|---------------|---------------|
| Ojo regular | Longitud (mm) | Ojo de muelle |
| 152610 | 23 mm | 152650 |
| 152611 | 28 mm | 152651 |
| 152612 | 38 mm | 152652 |
| 152613 | 48 mm | 152653 |
| 152614 | 53 mm | 152654 |



| Recta, punta triangular invertida | | |
|-----------------------------------|---------------|---------------|
| Ojo regular | Longitud (mm) | Ojo de muelle |
| 152627 | 60 mm | |
| | 75 mm | 152660 |

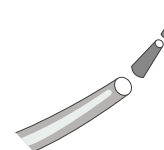

| Circular 1/2, cuerpo redondo, punta triangular | | |
|--|---------------|---------------|
| Ojo regular | Longitud (mm) | Ojo de muelle |
| 152617 | 23 mm | 152657 |



Agujas de sutura y portas

AGUJA DE SUTURA SKI TRIANGULAR



200741 Nº1

200742 Nº2

200743 Nº3

200744 Nº4

200745 Nº5

200746 Nº6

AGUJA DE SUTURA EN "S" TRIANGULAR



200747 Nº1

200748 Nº2

200749 Nº3

200750 Nº4

200751 Nº5

200752 Nº6

AGUJA DE SUTURA RECTA TRIANGULAR



200753 Nº1

200754 Nº2

200755 Nº3

200756 Nº4

200757 Nº5

200758 Nº6



Porta-agujas Mathieu-Olsen tungsteno

| 17 cm | 20 cm |
|--------|--------|
| 200781 | 200782 |



Ref. 200783

Pinza de sutura tipo Pean 14 cm

MATERIAL QUIRÚRGICO

Grapas y agujas de sutura



Ref. 200701

Pinza para grapas Michel 12,5 cm



Ref. 200702

Pinza para grapas 16,5 cm



200763

200764

Aguja de sutura Deschamps

| Izquierda | Derecha |
|---------------|---------------|
| 200763 | 200764 |

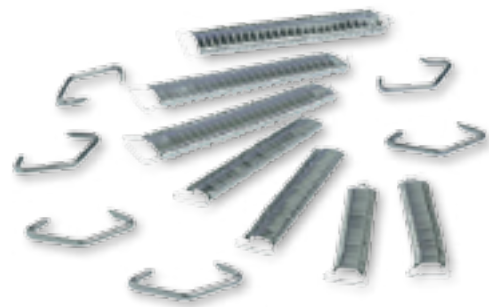

Ágrafes C/100 uds

| Medida | Ref. | Medida | Ref. |
|--------------|---------------|--------------|---------------|
| 11 mm | 200647 | 18 mm | 200651 |
| 14 mm | 200649 | 29 mm | 200655 |



Ref. 200641

Cinta sutura Bovivet 5 mts



Ref. 200657

Grapadora desechable 35 grapas



Ref. 200659

Quitagrapas



Ref. 200703

Aguja de sutura Buhner 30 cm



Ref. 200704

Aguja de sutura Gerlach 30 cm



Ref. 300695

Cuchilla especial cesáreas

Suturas absorbibles



| Catgut crómico Kruuse P/18 uds | | | | | |
|--------------------------------|-------------|-----|-----|-------|--------|
| Forma aguja | long. aguja | USP | EP | long. | Ref. |
| | 24 mm | 4-0 | 2 | 70 cm | 152208 |
| | 26 mm | 3-0 | 3 | 70 cm | 152206 |
| | 26 mm | 2-0 | 3,5 | 70 cm | 152204 |
| | 30 mm | 0 | 4 | 70 cm | 152200 |
| | 36 mm | 1 | 5 | 70 cm | 152202 |
| | 24 mm | 4-0 | 2 | 70 cm | 152209 |
| | 26 mm | 3-0 | 3 | 70 cm | 152207 |
| | 26 mm | 2-0 | 3,5 | 70 cm | 152205 |
| | 30 mm | 0 | 4 | 70 cm | 152201 |
| | 36 mm | 1 | 5 | 70 cm | 152203 |

| PGA Kruuse P/18 uds | | | | | |
|---------------------|-------------|-----|-----|-------|--------|
| Forma aguja | long. aguja | USP | EP | long. | Ref. |
| | 24 mm | 4-0 | 1,5 | 70 cm | 152408 |
| | 26 mm | 3-0 | 2 | 70 cm | 152406 |
| | 26 mm | 2-0 | 3 | 70 cm | 152404 |
| | 30 mm | 0 | 3,5 | 70 cm | 152401 |
| | 30 mm | 0 | 3,5 | 90 cm | 152412 |
| | 30 mm | 1 | 4 | 90 cm | 152413 |
| | 36 mm | 1 | 4 | 70 cm | 152402 |
| | 36 mm | 2 | 5 | 90 cm | 152414 |
| | 24 mm | 4-0 | 1,5 | 70 cm | 152407 |
| | 26 mm | 3-0 | 2 | 70 cm | 152405 |
| | 26 mm | 2-0 | 3 | 70 cm | 152403 |
| | 30 mm | 0 | 3,5 | 70 cm | 152400 |
| | 30 mm | 0 | 3,5 | 90 cm | 152409 |
| | 30 mm | 1 | 4 | 90 cm | 152410 |
| | 36 mm | 2 | 5 | 90 cm | 152411 |



| Catgut crómico Kruuse | | | |
|-----------------------|-----|-------|--------|
| USP | EP | long. | Ref. |
| 3-0 | 3 | 100 m | 152445 |
| 2-0 | 3,5 | 100 m | 152443 |
| 0 | 4 | 100 m | 152440 |
| 1 | 5 | 75 m | 152441 |
| 2 | 6 | 50 m | 152442 |
| 3 | 7 | 50 m | 152444 |
| 4 | 8 | 30 m | 152446 |
| 5 | 9 | 30 m | 152447 |

| PGA Kruuse | | | |
|------------|-----|-------|--------|
| USP | EP | long. | Ref. |
| 3-0 | 2 | 15 m | 152495 |
| 2-0 | 3 | 15 m | 152493 |
| 0 | 3,5 | 15 m | 152490 |
| 1 | 4 | 15 m | 152491 |
| 2 | 5 | 15 m | 152492 |
| 3+4 | 6 | 15 m | 152494 |



MATERIAL QUIRÚRGICO

Suturas absorbibles



| Monofast Kruse P/18 uds | | | | | |
|-------------------------|-------------|-----|-----|-------|--------|
| Forma aguja | long. aguja | USP | EP | long. | Ref. |
| | 13 mm | 5-0 | 1 | 45 cm | 152237 |
| | 13 mm | 4-0 | 1,5 | 45 cm | 152235 |
| | 19 mm | 4-0 | 1,5 | 45 cm | 152233 |
| | 19 mm | 4-0 | 1,5 | 70 cm | 152234 |
| | 19 mm | 3-0 | 2 | 45 cm | 152229 |
| | 19 mm | 3-0 | 2 | 70 cm | 152230 |
| | 24 mm | 3-0 | 2 | 70 cm | 152231 |
| | 24 mm | 2-0 | 3 | 70 cm | 152226 |
| | 26 mm | 3-0 | 2 | 70 cm | 152228 |
| | 26 mm | 2-0 | 3 | 70 cm | 152225 |
| | 26 mm | 0 | 3,5 | 70 cm | 152220 |
| | 30 mm | 0 | 3,5 | 70 cm | 152222 |
| | 36 mm | 1 | 4 | 70 cm | 152223 |
| | 13 mm | 5-0 | 1 | 45 cm | 152236 |
| | 24 mm | 4-0 | 1,5 | 70 cm | 152232 |
| | 26 mm | 2-0 | 3 | 70 cm | 152224 |
| | 26 mm | 3-0 | 2 | 70 cm | 152227 |
| | 30 mm | 0 | 3,5 | 70 cm | 152221 |

| Sacryl Kruse P/18 uds | | | | | |
|-----------------------|-------------|-----|-----|-------|--------|
| Forma aguja | long. aguja | USP | EP | long. | Ref. |
| | 6,5 mm | 8-0 | 0,4 | 30 cm | 152314 |
| | 13 mm | 6-0 | 0,7 | 45 cm | 152313 |
| | 16 mm | 6-0 | 0,7 | 70 cm | 152312 |
| | 16 mm | 5-0 | 1 | 45 cm | 152310 |
| | 19 mm | 5-0 | 1 | 45 cm | 152309 |
| | 19 mm | 4-0 | 1,5 | 70 cm | 152303 |
| | 19 mm | 3-0 | 2 | 45 cm | 152300 |
| | 19 mm | 3-0 | 2 | 70 cm | 152297 |
| | 22 mm | 6-0 | 0,7 | 45 cm | 152311 |
| | 22 mm | 5-0 | 1 | 45 cm | 152308 |
| | 24 mm | 4-0 | 1,5 | 70 cm | 152304 |
| | 24 mm | 3-0 | 3 | 70 cm | 152296 |
| | 24 mm | 2-0 | 3 | 70 cm | 152290 |
| | 30 mm | 3-0 | 2 | 70 cm | 152301 |
| | 30 mm | 2-0 | 3 | 70 cm | 152294 |
| | 30 mm | 0 | 3,5 | 70 cm | 152280 |
| | 36 mm | 4-0 | 1,5 | 45 cm | 152306 |
| | 36 mm | 1 | 4 | 70 cm | 152286 |
| | 36 mm | 2-0 | 3 | 70 cm | 152295 |
| | 36 mm | 0 | 3,5 | 70 cm | 152283 |
| | 40 mm | 0 | 3,5 | 70 cm | 152284 |
| | 48 mm | 0 | 3,5 | 70 cm | 152285 |
| | 48 mm | 1 | 4 | 70 cm | 152288 |
| | 48 mm | 2 | 5 | 90 cm | 152289 |
| | 22 mm | 3-0 | 2 | 70 cm | 152298 |
| | 24 mm | 4-0 | 1,5 | 70 cm | 152305 |
| | 26 mm | 3-0 | 2 | 70 cm | 152299 |
| | 26 mm | 2-0 | 3 | 70 cm | 152291 |
| | 30 mm | 0 | 3,5 | 70 cm | 152281 |
| | 36 mm | 2-0 | 3 | 70 cm | 152293 |
| | 36 mm | 1 | 4 | 70 cm | 152287 |



Suturas no absorbibles



| Supramid Kruse | | | |
|----------------|-----|-------|--------|
| USP | EP | long. | Ref. |
| 3-0 | 2 | 100 m | 152485 |
| 2-0 | 3 | 100 m | 152483 |
| 0 | 3,5 | 100 m | 152480 |
| 1 | 4 | 100 m | 152481 |
| 2 | 5 | 75 m | 152482 |
| 3+4 | 6 | 50 m | 152484 |

| Supramid Kruse P/18 uds | | | | | |
|-------------------------|-------------|-----|-----|-------|--------|
| Forma aguja | long. aguja | USP | EP | long. | Ref. |
| | 19 mm | 3-0 | 2 | 45 cm | 152399 |
| | 24 mm | 3-0 | 2 | 45 cm | 152398 |
| | 24 mm | 2-0 | 3 | 45 cm | 152395 |
| | 26 mm | 3-0 | 2 | 70 cm | 152392 |
| | 26 mm | 2-0 | 3 | 70 cm | 152391 |
| | 30 mm | 3-0 | 2 | 45 cm | 152397 |
| | 30 mm | 2-0 | 3 | 45 cm | 152394 |
| | 30 mm | 0 | 3,5 | 70 cm | 152390 |
| | 39 mm | 3-0 | 2 | 70 cm | 152396 |
| | 39 mm | 2-0 | 3 | 70 cm | 152393 |



| Silk Kruse | | | |
|------------|-----|-------|--------|
| USP | EP | long. | Ref. |
| 3-0 | 2 | 100 m | 152475 |
| 2-0 | 3 | 100 m | 152473 |
| 0 | 3,5 | 100 m | 152470 |
| 1 | 4 | 100 m | 152471 |
| 2 | 5 | 100 m | 152472 |
| 3+4 | 6 | 50 m | 152474 |
| 5 | 7 | 50 m | 152476 |

| Silk Kruse P/18 uds | | | | | |
|---------------------|-------------|-----|-----|-------|--------|
| Forma aguja | long. aguja | USP | EP | long. | Ref. |
| | 24 mm | 4-0 | 1,5 | 70 cm | 152383 |
| | 26 mm | 3-0 | 2 | 70 cm | 152382 |
| | 26 mm | 2-0 | 3 | 70 cm | 152381 |
| | 30 mm | 0 | 3,5 | 70 cm | 152380 |

Características Suturas Kruse

| | Modelo | Características físicas | Composición | Tiempo absorción |
|------------------------|-------------------------------|--|--|------------------|
| SUTURAS ABSORBIBLES | ✓ KRUSE MONOFAST | Monofilamento | Poligliconato | Corta |
| | ✓ KRUSE SACRYL | Multifilamento recubierto | Poliglactin 910 | Media |
| | ✓ KRUSE PGA | Multifilamento recubierto | Ácido policlicólico | Media |
| | ✓ KRUSE CHROMIC CATGUT | Multifilamento con apariencia de monofilamento | Colágeno purificado tratado con sales de cromo | Media |
| SUTURAS NO ABSORBIBLES | ✓ KRUSE SUPRAMID | Pseudo-monofilamento | Poliamida | |
| | ✓ KRUSE SILK | Seda multifilar | Seda | |

Paños/Goteros



201603

Ref. 201601

Gotero Luer-Lock

Ref. 201603

Gotero Luer-Lock con regulador de flujo



Cubierta estéril Buster
para cirugía P/25 uds. individuales

| Medida | Ref. | Medida | Ref. |
|--------|--------|---------|--------|
| 30x40 | 201243 | 120x120 | 201249 |
| 60x90 | 201245 | 120x180 | 201251 |
| 90x120 | 201247 | 120x250 | 201253 |



Ref. 201605

Sangofix B sin látex



Cubierta estéril y absorbente
Buster P/25 uds

| 38x45 cm | 45x75 cm | 75x90 cm |
|----------|----------|----------|
| 201255 | 201257 | 201259 |



Ref. 141865

Spray adhesivo BUSTER
para cubiertas 150 mL



Ref. 201241

Paño campo absorbente
Buster 45x60 cm 30x10 uds

Vendas/Gasas



Ref. 201201

Gasa estéril 8 capas
7x10 cm C/150 uds



Ref. 201203

Gasa estéril 12 capas
10x20 cm C/75 uds



Gasa no estéril P/100 uds

| Medida | 8 capas | 16 capas |
|------------|---------|----------|
| 5x5 cm | 201215 | |
| 7,5x7,5 cm | 201217 | |
| 10x10 cm | 201219 | 201221 |



Ref. 201205

Venda de gasa 7 cm x 5 mts
P/20 uds



Ref. 201225

Algodón hidrófilo 1 kg



Ref. 201207

Venda de gasa 10 cm x 10 mts
P/50 uds



Vendas de yeso P/2 uds

| | |
|-----------|--------|
| 5x270 cm | 201231 |
| 10x270 cm | 201233 |
| 15x270 cm | 201235 |
| 20x270 cm | 201237 |

MATERIAL QUIRÚRGICO

Necropsias

Ref. 201033

Kit necropsia completo Kruuse

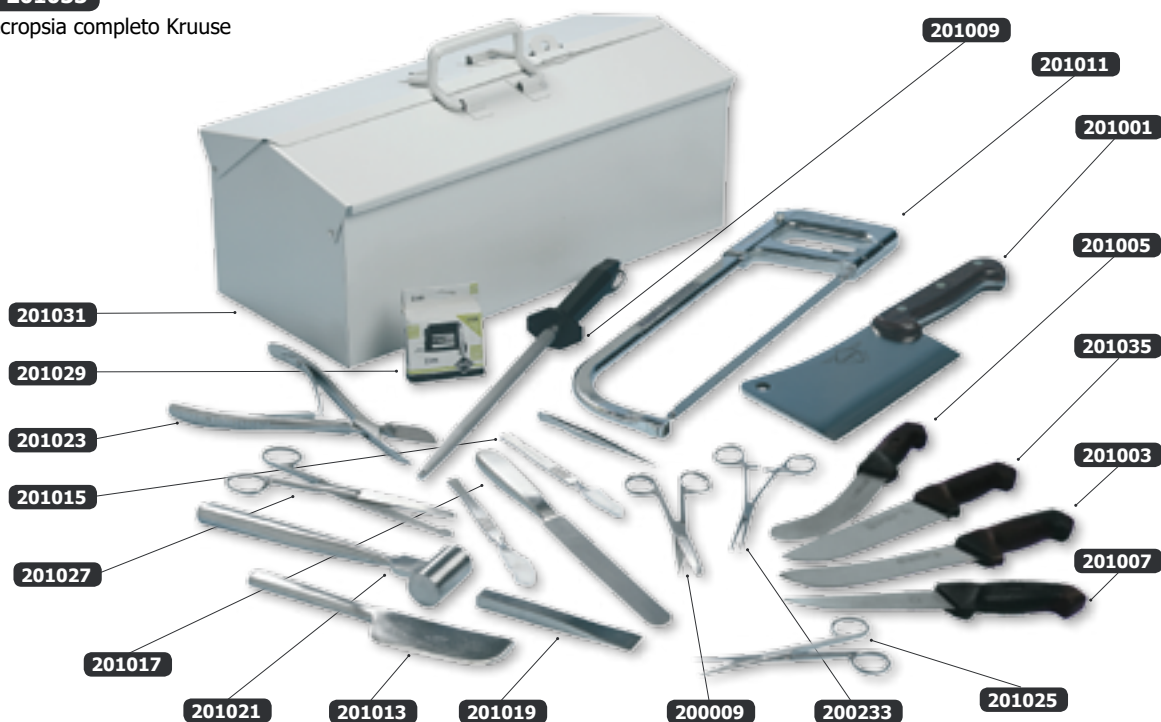

| Composición del Kit | | | | | |
|--------------------------------------|--------|---------------------------------|--------|---------------------------------------|--------|
| Componente | Ref. | Componente | Ref. | Componente | Ref. |
| Hachuela | 201001 | Cinzel inoxidable para huesos | 201019 | Pinza Rochester recta calidad B 16 cm | 200233 |
| Sierra de huesos con hoja inoxidable | 201011 | Martillo para autopsia | 201021 | Cinta 2 metros | 201029 |
| Recambio hoja sierra huesos | 201037 | Tijera para huesos 23 cm | 201023 | Caja metal con cajón 45x20x18 cm | 201031 |
| Cinzel inox. para médula espinal | 201013 | Tijera intestinal 21 cm | 201025 | Cuchillo degüello 21 cm | 201038 |
| Cuchillo inoxidable para cerebro | 201015 | Tijera disección recta 14 cm | 201027 | Cuchillo disección curvo 21,5 cm | 201003 |
| Cuchillo para tendones | 201017 | Tijera recta estándar R/A 16 cm | 200009 | Cuchillo disección curvo 15 cm | 201005 |
| Cuchillo disección agudo 15 cm | 201007 | Afilador de acero 25 cm | 201009 | Cuchillo disección agudo 21 cm | 201035 |



Bisturís



Ref. 200801

Hoja bisturí P/100
nº 10



Ref. 200803

Hoja bisturí P/100
nº 11



Ref. 200805

Hoja bisturí P/100
nº 12



Ref. 200807

Hoja bisturí P/100
nº 15



Ref. 200808

Hoja bisturí P/100
nº 18



Ref. 200809

Hoja bisturí P/100
nº 20



Ref. 200811

Hoja bisturí P/100
nº 21



Ref. 200813

Hoja bisturí P/100
nº 22



Ref. 200815

Hoja bisturí P/100
nº 23



Ref. 200817

Hoja bisturí P/100
nº 24



Ref. 200821

Mango bisturí nº 3



Ref. 200823

Mango bisturí nº 4



Bisturís desechables P/10 uds

| | |
|-------|--------|
| Nº 10 | 200827 |
| Nº 11 | 200829 |
| Nº 15 | 200831 |
| Nº 22 | 200833 |
| Nº 24 | 200835 |



Ref. 200840

Electrobisturí ES350

MATERIAL QUIRÚRGICO

Obstetricia



| Embriotomo Thygesen | | |
|---------------------|--------|-----------------|
| 85 cm | 100 cm | 85 cm divisible |
| 300671 | 300673 | 300675 |



Ref. 300683
Empuñadura con ranura embriotomo Thygesen



Ref. 300682
Embudo recambio



Ref. 300684
Pasador de sirga embriotomo Thygesen



Ref. 300681
Cabeza recambio



Ref. 300688
Mango sirga cromado



Ref. 300687
Mango sirga Thygesen inoxidable



Ref. 300686
Mango sirga Nielsen inoxidable



Ref. 450433
Sirga Bovivet 10 metros



300649

300651

| Gancho ocular Harms | |
|---------------------|--------|
| Agudo | Romo |
| 300649 | 300651 |



| Gancho articulado Krey | |
|------------------------|-----------|
| Calidad A | Calidad B |
| 300641 | 300643 |



Ref. 300607
Cadena obstetricia con mangos



Ref. 300627
Aguja para grapa Flessa



Ref. 300626
Férula metal Flessa



| Imperdible vaginal P/5 uds | | |
|----------------------------|-------------|------------|
| Vacuno 13 cm | Ovino 10 cm | Ovino 8 cm |
| 300611 | 300613 | 300615 |



Ref. 300645
Gancho para partos modelo Moses 6x800 mm

Obstetricia



Ref. 300703
Catéter uterino metal



Ref. 300701
Catéter uterino Bovivet
P/25 uds



Ref. 32-01
Pelvímetro novillas



Ref. N31603
Metricheck



| Gel Bovivet | | |
|-------------|---------|----------|
| 500 mL | 1 litro | 5 litros |
| 300453 | 300454 | 300455 |



Dosificadores bucales/Garrochas



Ref. 250203

Dosificador bucal automático 30 mL



Ref. 250205

Mochila dosificador bucal



250241



Ref. 250249

Jeringa dosificadora Ukal
250 mL

| Dosificador manual Ukal | | | | |
|-------------------------|--------|--------|--------|--------|
| 35 mL | 70 mL | 200 mL | 300 mL | 500 mL |
| 250241 | 250243 | 250245 | 250247 | 250248 |



Jeringa Garrocha

| 20 cm | 30 cm |
|--------|--------|
| 250321 | 250323 |



250325

250327

| Aguja jeringa Garrocha | |
|------------------------|------------|
| Intramuscular | Subcutánea |
| 250325 | 250327 |



Revólver Multimatic

| 25 mL | 50 mL |
|--------|--------|
| 250751 | 250755 |



Cilindro Multimatic

| 25 mL | 50 mL |
|--------|--------|
| 250757 | 250759 |



Ref. 250721

Revólver plástico 50 mL

Jeringa intradérmica Dermojet



Ref. 251300

Jeringa Dermojet

Jeringa para inyecciones intradérmicas. Está provista de una cabeza monodosis regulada a 0,1 mL y que proporciona alrededor de 40 dosis. Tiene forma cilíndrica y consta de cuatro elementos:

- El cuerpo del inyector de acero inoxidable, un pistón central, un muelle de tensión y una palanca de armamento
- La cabeza de inyección que incluye la mayoría de las piezas fungibles: juntas, filtros y la tobera de rubí por donde se expulsa el líquido
- El depósito que contiene el líquido que será inyectado. Tiene una capacidad de 4 mL (40 dosis de 0,1 mL)
- El cabezal fijo con forma de anillo en acero inoxidable

No utilice la Dermojet en vacío.

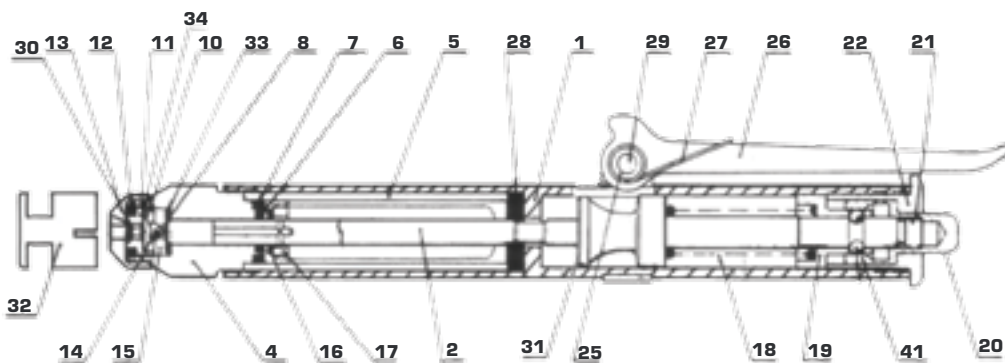

| Recambios Dermojet | | |
|-----------------------------|------|--------|
| Cuerpo descubierto | (1) | 251301 |
| Conjunto pistón | (2) | 251302 |
| Cabeza eyección descubierta | (4) | 251304 |
| Tubo depósito | (5) | 251305 |
| Junta tórica R3 pistón | (6) | 251306 |
| Junta tórica R3 (dep. inf.) | (7) | 251307 |
| Arandela teflón | (8) | 251308 |
| Filtro grueso | (33) | 251345 |
| Filtro fino | (34) | 251346 |
| Muelle válvula | (10) | 251310 |

| Recambios Dermojet | | |
|---------------------|------|--------|
| Asiento pastilla | (11) | 251311 |
| Junta tórica cabeza | (12) | 251312 |
| Tuerca de pastilla | (13) | 251313 |
| Válvula | (14) | 251314 |
| Asiento válvula | (15) | 251315 |
| Cara soporte | (16) | 251316 |
| Tuerca cara soporte | (8) | 251317 |
| Muelle principal | (33) | 251318 |
| Caja de bolas | (34) | 251319 |
| Bolas | (41) | 251341 |

| Recambios Dermojet | | |
|--------------------------------|------|--------|
| Botón de suelta | (20) | 251320 |
| Muelle botón | (21) | 251321 |
| Tuerca cierre superior | (22) | 251322 |
| Casquillo de palanca | (25) | 251325 |
| Palanca armamento | (26) | 251326 |
| Muelle alfiler palanca | (27) | 251327 |
| Junta tórica superior depósito | (28) | 251328 |
| Eje de palanca | (29) | 251329 |
| Inyector rubí | (30) | 251330 |
| Junta dentro collarín | (31) | 251331 |
| Protector delantero | (32) | 251332 |

(*) Las reparaciones de las jeringas intradérmicas Dermojet se realizan según las indicaciones del fabricante y se utilizan piezas originales.

Revólver Hauptner



| Revólver Hauptner | |
|-------------------|--------|
| 25 mL | 250601 |
| 30 mL | 250603 |
| 50 mL | 250605 |



| Cristal Hauptner | |
|------------------|--------|
| 25 mL | 250611 |
| 30 mL | 250612 |
| 50 mL | 250613 |



Ref. 250607
Alargadera Hauptner

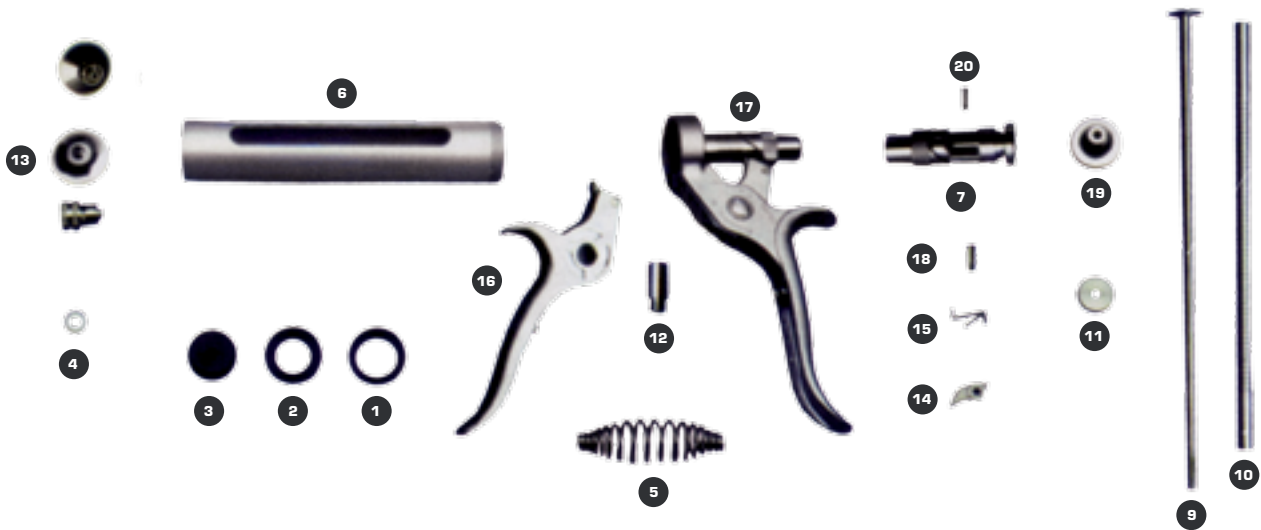

| Recambios revólver Hauptner | | | | |
|-----------------------------|------|--------|--------|--------|
| | | 25 mL | 30 mL | 50 mL |
| Junta anterior | (1) | 250620 | 250622 | |
| Junta posterior | (2) | 250621 | 250623 | |
| Émbolo | (3) | 250617 | 250618 | |
| Arandela rosca cono | (4) | | 250626 | |
| Muelle maneta | (5) | | 250627 | |
| Casquillo | (6) | 250629 | 250630 | 250631 |
| Casquillo ajuste completo | (7) | 250633 | 250634 | 250635 |
| Varilla interior | (9) | 250639 | 250640 | 250641 |
| Varilla exterior dentada | (10) | 250643 | 250644 | 250645 |

| Recambios revólver Hauptner | | | | |
|-----------------------------|------|--------|--------|-------|
| | | 25 mL | 30 mL | 50 mL |
| Disco varilla interior | (11) | 250647 | 250648 | |
| Tornillo maneta | (12) | | 250628 | |
| Cono Luer-Lock | (13) | 250652 | 250653 | |
| Uña revólver | (14) | | 250656 | |
| Resorte uña revólver | (15) | | 250657 | |
| Maneta delantera | (16) | 250658 | 250660 | |
| Maneta trasera | (17) | 250659 | 250661 | |
| Tornillo uña | (18) | | 250655 | |
| Tornillo expansión | (19) | | 250650 | |
| Pasador casquillo ajuste | (20) | | 250637 | |

Revólver Roux



| Revólver Roux | |
|---------------|--------|
| 10 mL | 250669 |
| 30 mL | 250670 |
| 50 mL | 250671 |



| Cristal Roux | |
|--------------|--------|
| 10 mL | 250675 |
| 30 mL | 250676 |
| 50 mL | 250677 |



| Kit recambio Roux | |
|-------------------|--------|
| 10 mL | 250682 |
| 30/50 mL | 250683 |



Ref. 250673

Revólver Roux
con alargadera 50 mL

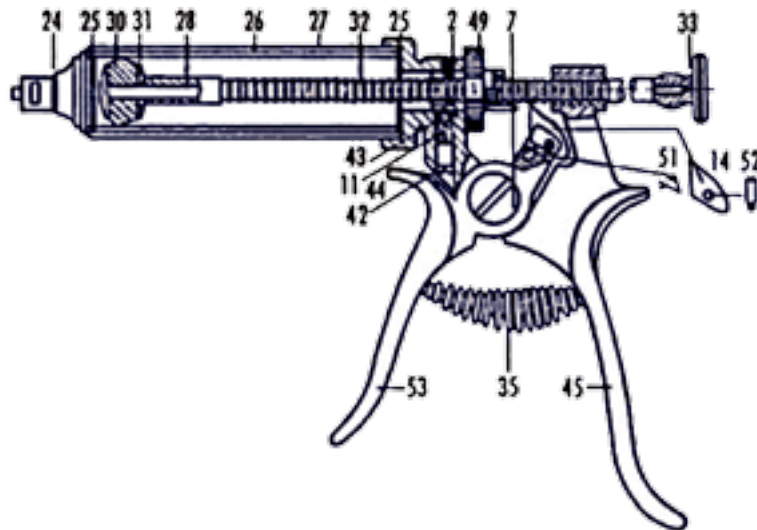

| Recambios revólver Roux | | | | |
|--------------------------|------|--------|--------|--------|
| | | 10 mL | 30 mL | 50 mL |
| Tornillo dosificador | (2) | | 250678 | |
| Tornillo fijación | (7) | | 250680 | |
| Muelle dosificador | (11) | | 250681 | |
| Uña | (14) | | 250706 | |
| Cono luer-lock | (24) | 250684 | 250685 | |
| Carcasa | (27) | 250688 | 250689 | 250690 |
| Varilla interior | (28) | 250691 | 250692 | 250693 |
| Varilla exterior dentada | (32) | 250698 | 250699 | 250700 |
| Disco émbolo | (31) | 250696 | 250697 | |

| Recambios revólver Roux | | | | |
|-------------------------|------|--------|--------|-------|
| | | 10 mL | 30 mL | 50 mL |
| Tornillo expansión | (33) | | 250701 | |
| Muelle maneta | (35) | | 250702 | |
| Tornillo | (42) | | 250703 | |
| Bola de acero | (43) | | 250710 | |
| Maneta trasera | (45) | 250704 | 250705 | |
| Disco dosificador | (49) | | 250707 | |
| Resorte uña | (51) | | 250708 | |
| Tornillo uña | (52) | | 250709 | |
| Maneta delantera | (53) | | 250679 | |

Jeringas Socorex



| Jeringa Socorex tubo alimentación | | | |
|-----------------------------------|--------|-------|--------|
| 0,5 mL | 250801 | 5 mL | 250807 |
| 1 mL | 250803 | 10 mL | 250809 |
| 2 mL | 250805 | 20 mL | 250811 |

Ref. 250909
Alargadera 30 cm

SOCOREX
SWISS

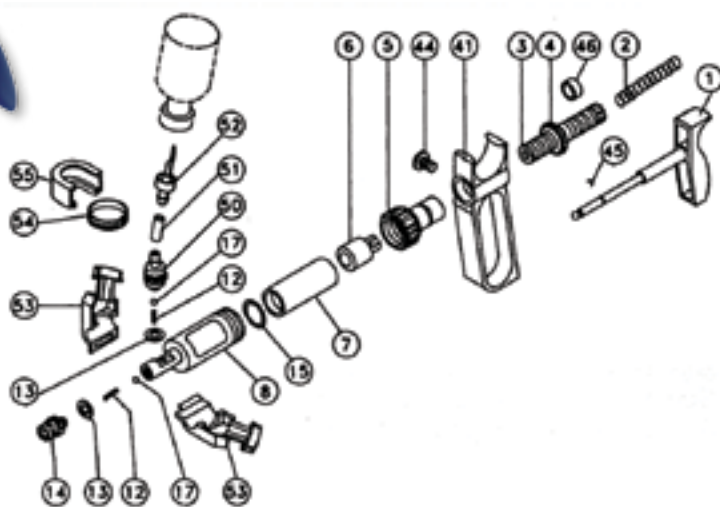

| Jeringa Socorex portafrasco | | | |
|-----------------------------|--------|-------|--------|
| 0,5 mL | 250813 | 5 mL | 250819 |
| 1 mL | 250815 | 10 mL | 250821 |
| 2 mL | 250817 | | |



Ref. 250825

Jeringa automática doble 2 mL

| Recambios revólver Socorex | | | | | | | | |
|----------------------------|------|--------|--------|--------|--------|--------|--------|--|
| | | 0,5 mL | 1 mL | 2 mL | 5 mL | 10 mL | 20 mL | |
| Maneta vástago | (1) | 250852 | 250853 | 250854 | 250855 | 250856 | 250857 | |
| Muelle vástago | (2) | 250858 | 250859 | 250860 | 250861 | 250862 | | |
| Casquillo | (3) | 250863 | 250864 | 250865 | 250866 | 250867 | | |
| Cursor | (4) | 250868 | 250869 | | 250870 | 250871 | | |
| Capuchón | (5) | 250872 | 250873 | 250874 | 250875 | 250876 | 250877 | |
| Émbolo | (6) | 250878 | 250879 | 250880 | 250881 | 250882 | | |
| Cuerpo | (8) | 250883 | 250884 | 250885 | 250886 | 250887 | | |
| Cono Luer-Lock | (14) | 250902 | | | | | | |
| Empuñadura | (41) | 250889 | | | | | 250890 | |
| Tornillo | (44) | 250891 | | | | | 250892 | |
| Clip maneta | (45) | 250893 | | | | | | |
| Arandela maneta | (46) | 250894 | | | | | | |

Repuestos Socorex



| Cristal Socorex | | | |
|-----------------|--------|-------|--------|
| 0,5 mL | 250835 | 5 mL | 250838 |
| 1 mL | 250836 | 10 mL | 250839 |
| 2 mL | 250837 | 20 mL | 250840 |



Ref. 250907
Goma aspiración jeringa



| Kit portafrasco | |
|---------------------------|--------|
| Kit portafrasco | 250847 |
| Aguja portafrasco | 250848 |
| Válvula +racord 0,5/1 mL | 250900 |
| Válvula +racord 2/5/10 mL | 250901 |
| Válvula botella Socorex | 250903 |
| Arandela portafrasco | 250850 |
| Cuerpo portafrasco | 250849 |
| Rosca portafrasco | 250851 |



| Kit repuesto Socorex | | | |
|----------------------|--------|-------|--------|
| 0,5 mL | 250841 | 5 mL | 250844 |
| 1 mL | 250842 | 10 mL | 250845 |
| 2 mL | 250843 | 20 mL | 250846 |



Ref. 250908
Aguja aspiración jeringa



| Botella Socorex | |
|-----------------|--------|
| 60 mL | 250904 |
| 125 mL | 250905 |
| 250 mL | 250906 |



Tuberculina/Cutímetros



Ref. 251001
Jeringa tuberculina TBC



Ref. 251083
Cutímetro Kruuse



Ref. 251013
Cono luer-lock jeringa TBC



Ref. 251005
Aguja tuberculina TBC



Ref. 251011
Cristal 1,8 mL jeringa TBC



Ref. 251021
Jeringa tuberculina con aguja
1mL desechable C/100 uds

Vacunadores



| Vacunador Ferromatic | |
|----------------------|-------|
| 3 mL | 5 mL |
| 23200 | 23210 |



Ref. 250941
Vacunador Muto Hauptner 5 mL



Ref. 250615
Cristal Muto



Ref. 250945
Vacunador 5 mL Vet-Matic



| Vacunador Prima | | |
|-----------------|-----------|-------------|
| | Tubo | Portafrasco |
| 2 mL | 110040102 | 110040202 |
| 5 mL | 110040105 | 110040205 |



| Eco-Matic portafrasco | |
|-----------------------|--------|
| 0,3 mL | 250921 |
| 2 mL | 250923 |
| 5 mL | 250925 |



Ref. 250931
Kit adaptación frasco Eco-Matic



| Eco-Matic tubo | |
|----------------|--------|
| 2 mL | 250927 |
| 5 mL | 250929 |

Jeringas desechables/Agujas



Jeringa desechable 3 cuerpos estéril

| | | | |
|-------------|--------|------------|--------|
| 1 mL C/100 | 251421 | 20 mL C/50 | 251429 |
| 2 mL C/100 | 251423 | 30 mL C/50 | 251431 |
| 5 mL C/100 | 251425 | 50 mL C/25 | 251433 |
| 10 mL C/100 | 251427 | 100 mL ud. | 251435 |



Jeringa desechable 2 cuerpos estéril

| | | | |
|------------|--------|-------------|--------|
| 1 mL C/100 | 251441 | 10 mL C/100 | 251405 |
| 2 mL C/100 | 251401 | 20 mL C/50 | 251407 |
| 5 mL C/100 | 251403 | 30 mL C/50 | 251409 |



AGUJAS HENKE PREMIUM C/10 uds

| L \ Ø | 1,0 | 1,2 | 1,4 | 1,6 | 1,8 | 2,0 |
|-------|--------|--------|--------|--------|--------|--------|
| 15 | 251701 | 251702 | 251703 | 251704 | 251705 | |
| 20 | 251706 | | 251707 | 251708 | 251709 | 251710 |
| 25 | | | | 251711 | 251712 | 251713 |
| 30 | | | | | 251714 | 251715 |
| 35 | | | | 251716 | 251717 | 251718 |
| 40 | | | | | | 251719 |
| 45 | | | | | | 251720 |



AGUJAS HIPODÉRMICAS C/12 uds

| L \ Ø | 10 | 12 | 13 | 15 | 18 | 20 |
|-------|--------|--------|--------|--------|--------|--------|
| 10 | 251601 | | 251602 | 251603 | | |
| 15 | 251604 | 251605 | | 251606 | 251607 | 251608 |
| 20 | 251609 | | | 251610 | 251611 | 251612 |
| 25 | | | | 251613 | 251614 | 251615 |
| 30 | | | | 251616 | 251617 | 251618 |
| 35 | | | | 251619 | 251620 | 251621 |
| 40 | | | | 251622 | 251623 | 251624 |
| 45 | | | | | 251625 | 251626 |
| 50 | | | | | 251627 | 251628 |



AGUJAS DESECHABLES C/100 uds

| L \ Ø | 10 | 16 | 25 | 38 | 40 | 50 | 60 | 80 |
|-------|--------|--------|--------|--------|--------|--------|--------|--------|
| 0,5 | | 251671 | | | | | | |
| 0,6 | | | 251672 | | | | | |
| 0,8 | 251673 | 251688 | 251674 | 251675 | | | | |
| 0,9 | | | 251676 | | 251677 | | | |
| 1,1 | | | 251678 | 251679 | | | | |
| 1,2 | | | | | 251680 | | | |
| 1,25 | | | | 251681 | | 251682 | | |
| 1,6 | | | 251689 | 251683 | 251693 | | | |
| 2,1 | | | | 251684 | | | 251685 | 251686 |

Varios jeringas



| Jeringa Ukalplex | | | |
|------------------|--------|--------|--------|
| 5 mL | 250401 | 30 mL | 250407 |
| 10 mL | 250403 | 50 mL | 250409 |
| 20 mL | 250405 | 100 mL | 250411 |



| Jeringa Bovivet | | |
|-----------------|--------|-----------|
| | Normal | Con rosca |
| 10 mL | 250431 | 250441 |
| 20 mL | 250433 | 250443 |
| 30 mL | 250435 | |
| 50 mL | 250437 | 250445 |



| Catéter Venocan PLUS IV C/50 uds | | | |
|----------------------------------|--------|---------------|--------|
| 0,7x19 mm 24G | 121906 | 1,3x45 mm 18G | 121909 |
| 0,9x25 mm 22G | 121907 | 1,7x50 mm 16G | 121910 |
| 1,1x33 mm 20G | 121908 | 2,1x50 mm 14G | 121911 |
| 1,3x32 mm 18G | 121912 | | |



Ref. 251811
Acoplador aguja



Ref. 251731
Contenedor agujas



Ref. 250281
Cánula bucal luer-lock 120 mm ukal

CURSOS DE FORMACIÓN ESPECIALIZADA PARA VETERINARIOS

HUMECO realiza formación y transferencia de tecnología en el área de la biotecnología de la reproducción animal y ecografía.

Organizamos cursos de formación personalizada para empresas. Los más demandados son nuestros cursos de capacitación de técnicos de laboratorio para centros de inseminación.

Nuestros cursos:

Cursos Básicos y Avanzados de Ecografía Reproductiva de la Hembra. (Vacuno, Equino, Ovino)

Evaluación Reproductiva del Macho. (Bovino, Porcino, Equino, Ovino)

Ecografía Visceral, Ecografía Músculo Esquelética o Abdominal

Técnicas de Análisis y Tratamiento del Semen en Laboratorio

Embriones: Transferencia, Congelación, Vitrificación de Embriones en Bovino y Equino.

Cursos de Endoscopia



MATERIAL DE PROTECCIÓN

Guantes



Guantes látex Krutex sin polvo C/100 uds

| T/P | T/M | T/L | T/XL |
|--------|--------|--------|--------|
| 700221 | 700223 | 700225 | 700227 |

Los guantes de examen de látex KRUTEX proporcionan una superficie lisa y extra delgada para una mayor sensibilidad y sensación. Sin polvo.

- Grosor dedos: 0,16 mm
- Grosor palma: 0,15 mm



Guantes látex Krutex con polvo C/100 uds

| T/P | T/M | T/L | T/XL |
|--------|--------|--------|--------|
| 700231 | 700233 | 700235 | 700237 |

Los guantes de examen de látex KRUTEX proporcionan una superficie lisa y extra delgada para una mayor sensibilidad y sensación. Con polvo de almidón de maíz.

- Grosor dedos: 0,16 mm
- Grosor palma: 0,15 mm



Guantes nitrilo Krutex C/100 uds

| T/P | T/M | T/L | T/XL |
|--------|--------|--------|--------|
| 700251 | 700253 | 700255 | 700257 |

Los guantes de examen de nitrilo KRUTEX son micro texturizados con buenas propiedades de agarre en seco y en húmedo, sin polvo, látex ni proteínas. Las puntas de los dedos con textura ofrecen una mayor sensibilidad.

- Grosor dedos: 0,15 mm
- Grosor palma: 0,13 mm



Guantes vinilo Krutex sin polvo C/100 uds

| T/P | T/M | T/L | T/XL |
|--------|--------|--------|--------|
| 700241 | 700243 | 700245 | 700247 |

Guantes de examinación de vinilo de alta calidad. No estériles. No espermicida. Para todos los procedimientos de examen.

- Grosor dedos: 0,15 mm
- Grosor palma: 0,12 mm



Ref. 700217

Guantes hombro Krutex P/50 uds

Guantes con cinta para el cuello de auto-sujeción para una protección del hombro y la axila. Suaves y resistentes para diferentes usos veterinarios e inseminaciones artificiales.

- Longitud: 90 cm
- Grosor: 25 micras



Ref. 700213

Guantes inseminación supersensitivos Krutex C/100 uds

Guantes de longitud hasta el hombro desechables, suaves, extremadamente fuertes y con sensibilidad muy alta. Cortado en diagonal para un mejor ajuste. Para exámenes rectales, inseminaciones artificiales y obstetricia.

- Longitud: 90 cm
- Grosor: 25 micras

Guantes



Opción de cajas personalizadas

Ref. 024761

Guantes supersensitivos IMV
C/100 uds

- Longitud: 920 mm
- Grosor: 23 micras
- Color: transparente
- Caja de 100 uds



Ref. 024199

Guantes inseminación Polysem 92 cm
C/100 uds

Especialmente desarrollado para la inseminación artificial, este guante de protección de polietileno también ofrece buena sensibilidad táctil para los controles de preñez.

- Longitud: 920 mm
- Grosor: 24 micras
- Color: naranja
- Caja de 100 uds



Ref. 024227

Guante polytactil estéril
C/100 uds

Para veterinarios exigentes en la búsqueda de una protección óptima, este guante de polietileno especialmente doblado también es ideal para la transferencia de embriones.

- Grosor: 33 micras
- Color: amarillo
- Caja de 100 uds envasados individualmente



Ref. 024248

Guantes inseminación Polysem 87 cm
C/200 uds

Un guante delgado para inseminación económica.

- Longitud: 870 mm
- Grosor: 20 micras
- Color: claro
- Caja de 200 uds

POLYSEM

MATERIAL DE PROTECCIÓN

Vestuario desechable



Ref. 260609

Bata partos con mangas
P/25 uds



Ref. 700401

Bata desechable visita
polipropileno



Ref. 700403

Bata partos desechable
Krutex P/20 uds



| Talla | Mono Tyvex |
|-------|------------|
| M | 700441 |
| L | 700443 |
| XL | 700445 |
| XXL | 700447 |



| Talla | Mono ProShield |
|-------|----------------|
| M | 700421 |
| L | 700423 |
| XL | 700425 |
| XXL | 700427 |



| Talla | Mono azul |
|-------|-----------|
| M | 700431 |
| L | 700433 |
| XL | 700435 |
| XXL | 700437 |



Ref. 700411

Kit completo visita
Composición: Bata, calzas
azules, mascarilla y gorro
circular.

MATERIAL DE PROTECCIÓN

Vestuario veterinario



| Talla | Mono para partos | Chaqueta partos | Pantalón partos | Peto tirantes partos |
|-------|------------------|-----------------|-----------------|----------------------|
| S | 751001 | 751011 | 751021 | 751031 |
| M | 751002 | 751012 | 751022 | 751032 |
| L | 751003 | 751013 | 751023 | 751033 |
| XL | 751004 | 751014 | 751024 | 751034 |

| Talla | Bata partos | Delantal para partos |
|--------|-------------|----------------------|
| 110 cm | | 751051 |
| 120 cm | 751041 | 751052 |
| 130 cm | 751042 | 751053 |
| 140 cm | 751043 | |
| 150 cm | 751044 | |
| 160 cm | 751045 | |



| Talla | Traje de lluvia Nylon |
|-------|-----------------------|
| S | 750631 |
| M | 750632 |
| L | 750633 |
| XL | 750634 |
| XXL | 750635 |
| 3XL | 750636 |



| Talla | Mono azul | Mono verde |
|-------|-----------|------------|
| S | 750601 | 750615 |
| M | 750602 | 750616 |
| L | 750603 | 750617 |
| XL | 750604 | 750618 |
| XXL | 750605 | 750619 |



Ref. 751061
Protector hombro Kruise

MATERIAL DE PROTECCIÓN

Protección general



700001

700017

Ref. 700001

Gorro circular P/100 uds

Ref. 700017

Mascarilla higiene 1 pliegue P/100 uds



Ref. 700021

Mascarilla cónica antipolvo P/50 uds



700031

Mascarillas

| FFP1D | FFP2D | FFP3D con válvula |
|--------|--------|-------------------|
| 700035 | 700033 | 700031 |



Ref. 700261

Guante corto polietileno C/100 uds



Ref. 750207

Guantes látex natural



Ref. 750021

Gafas V-MAXX



Ref. 700201

Manguito desechable polipropileno



Ref. 700601

Calza azul desechable P/100 uds



Ref. 700605

Cubrebotas con goma P/50 uds



Ref. 700611

Calza toma de muestras

DELTASEC

Polvo Secante



Nº Registro:
0652-H



Su alto poder de absorción lo posiciona como el secante más absorbente del mercado, hasta 3 litros de agua absorbida por kg de producto.

DELTASEC es:

- Biodegradable
- Expectorante
- Repelente de insectos
- Mejora el bienestar animal
- Respeta el medio ambiente
- Gran poder de absorción

DELTASEC contiene:

- Ingredientes de origen mineral
- Ingredientes de origen vegetal
- Ingredientes de origen marino
- Núcleo antibacterial
- Sustancias aromáticas
- Extractos de Yucca Shidigera



El bienestar animal mejora los rendimientos



Saco de 25 kg

Composición:

Ingredientes de origen mineral

Ingredientes de origen vegetal

Ingredientes de origen marino

Núcleo antibacterial

Sustancias aromáticas

Extractos de Yucca Shidigera

**SIN PERÍODO
DE SUPRESIÓN**

CAI-PANmint

EL ORIGINAL

PRODUCTO NATURAL SIN ANTIBIÓTICOS



**CREMA
con 35% puro CAI-PAN
Aceite de Menta
Japonés**



**CALMA Y TONIFICA LA UBRE
PRODUCTO NATURAL
NO CONTIENE ANTIBIÓTICOS
SIN PERÍODO DE SUPRESIÓN
UBRES SANAS**

Nº Registro
0156-H



Humeco
Productos veterinarios

Crotales ADN



| Botón ADN macho + hembra | | | | | |
|--------------------------|--------|--------|--------|--------|--------|
| | ● | ● | ● | ● | ● |
| Sin conservante | 051001 | 051003 | 051005 | 051007 | 051008 |
| Con conservante | 051009 | 051011 | 051013 | 051015 | 051017 |



| Crotal corderos ADN | | | | |
|---------------------|--------|--------|--------|--------|
| | ● | ● | ● | ● |
| Sin conservante | 051051 | 051053 | 051055 | 051057 |
| Con conservante | 051061 | 051063 | 051065 | 051067 |



| Botón hembra ADN toma muestras | |
|--------------------------------|-----------------|
| Sin conservante | Con conservante |
| 051091 | 051093 |

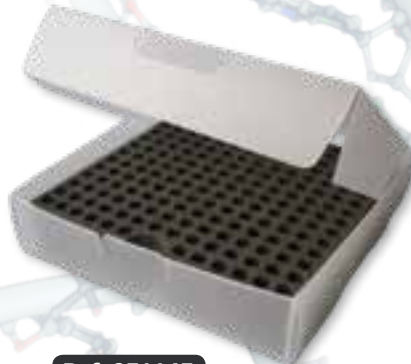

Ref. 051145
Caja estocaje 192 muestras ADN



Ref. 051147
Abretubos manual ADN

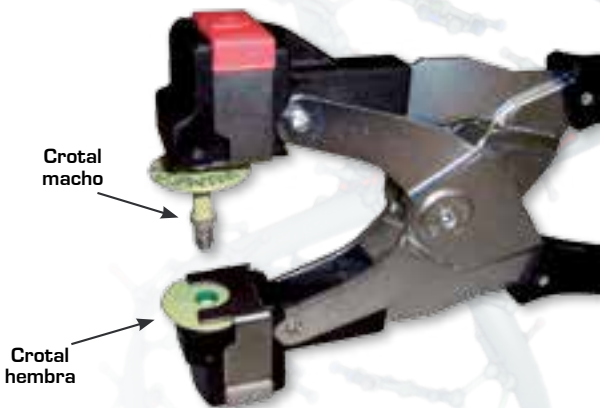

Ref. 051081
Tenaza crotal m+h ADN

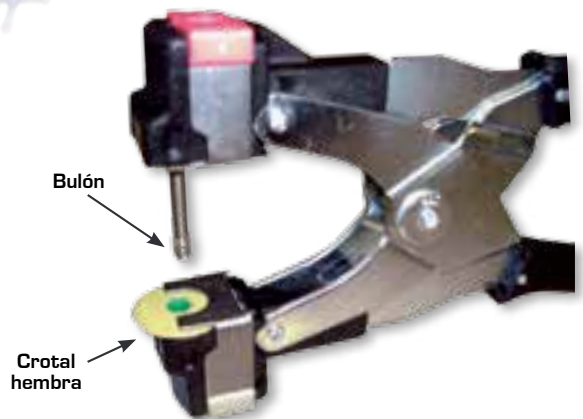

Ref. 051101
Tenaza crotal botón hembra ADN



Ref. 051083
Kit recambio tenaza m+h ADN



Ref. 051103
Kit recambio tenaza botón hembra ADN

Crotales electrónicos



Ref. 050878
Tenaza marcas Allflex



Ref. 050879
Punta recambio tenaza Allflex



Ref. 050877
Rotulador Allflex



Ref. 050874
Lector stick Allflex



Ref. 050871
Crotal electrónico FDX



Ref. 050872
Crotal electrónico HDX



Ref. 050873
Lector portátil Allflex

Microchips



Ref. 050655
Pistola para microchips inyectables



Ref. 050656
Microchip inyectable 15x3 mm



Ref. 050661
Microchip inyectable pequeños animales 12x2 mm



Ref. 050657
Microchip inyectable 12x2 mm



Ref. 050663
Microchip inyectable caballos 15x3 mm



Ref. 050658
Lector de microchips

Crotales plástico

| Crotal MAXI Allflex | | |
|---------------------|-------|--------|
| | Macho | Hembra |
| ● | | 050861 |
| ● | | 050862 |
| ● | | 050863 |
| ● | | 050864 |
| ● | | 050865 |
| ● | | 050866 |

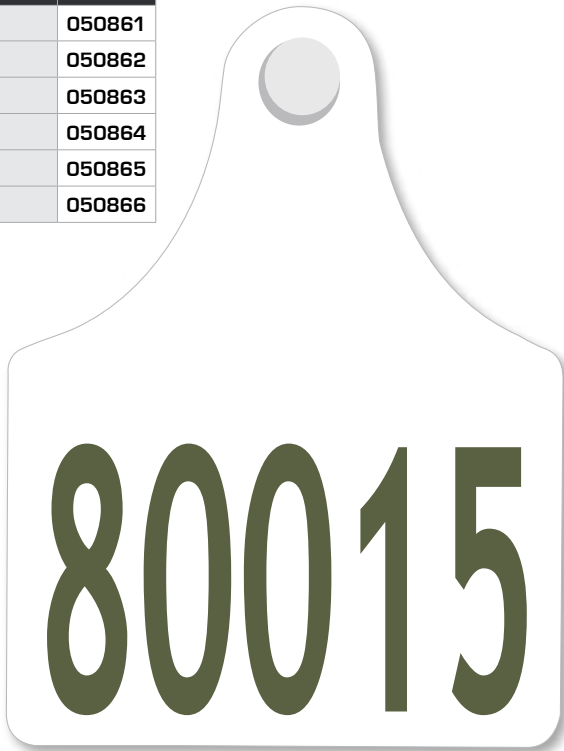

| Crotal JÚNIOR Allflex | | |
|-----------------------|--------|--------|
| | Macho | Hembra |
| ● | 050931 | 050831 |
| ● | 050932 | 050832 |
| ● | 050933 | 050833 |
| ● | 050934 | 050834 |
| ● | 050935 | 050835 |

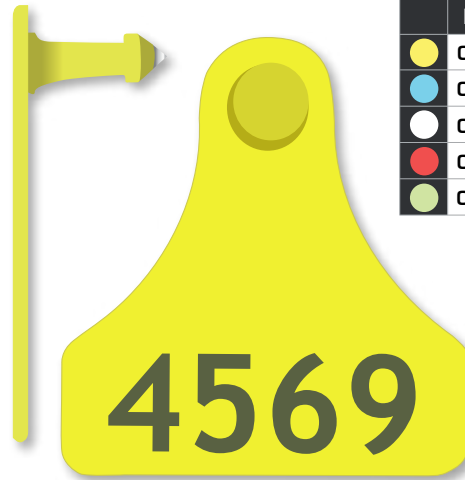

| Crotal MEDIANO Allflex | | |
|------------------------|--------|--------|
| | Macho | Hembra |
| ● | 050921 | 050821 |
| ● | 050922 | 050822 |
| ● | 050923 | 050823 |
| ● | 050924 | 050824 |
| ● | 050925 | 050825 |



| Crotal BOTÓN Allflex | | |
|----------------------|--------|--------|
| | Macho | Hembra |
| ● | 050901 | 050801 |
| ● | 050902 | 050802 |
| ● | 050903 | 050803 |
| ● | 050904 | 050804 |
| ● | 050905 | 050805 |
| ● | 050906 | 050806 |

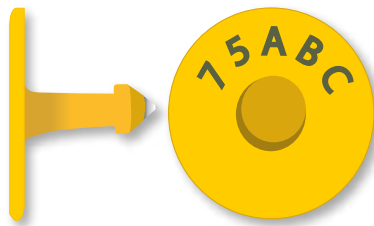

| Crotal SÉNIOR Allflex | | |
|-----------------------|--------|--------|
| | Macho | Hembra |
| ● | 050951 | 050851 |
| ● | 050952 | 050852 |
| ● | 050953 | 050853 |
| ● | 050954 | 050854 |
| ● | 050955 | 050855 |

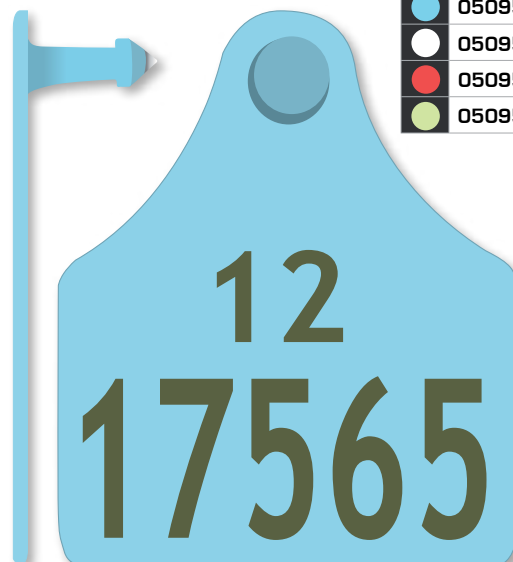

IDENTIFICACIÓN

Crotales varios



Ref. 050888

Tenaza marcas Tip Tag



Marcas Chevifix metal P/100 uds

| | | | | | |
|--------|--------|--------|--------|--------|--------|
| | | | | | |
| 050892 | 050894 | 050895 | 050896 | 050897 | 050898 |

Marcas Tip Tag P/20 uds

| | | | | | |
|--------|--------|--------|--------|--------|--------|
| | | | | | |
| 050881 | 050882 | 050883 | 050884 | 050885 | 050886 |

Marcas aves/Pequeños animales



Ref. 051401

Marca aves clic
P/100 uds

Ref. 051403

Marca aves clic
numeradas P/100 uds



Marcas Quick P/100 uds

| Numerada | Marcada | Numerada / Marcada |
|----------|---------|--------------------|
| 051461 | 051463 | 051465 |



Ref. 051409

Marca aves ala metal P/100 uds



Ref. 051467

Tenaza marcas Quick



Ref. 051407

Tenaza marca aves ala metal



Ref. 051459

Tenaza marcas simplex baby



Marcas simplex baby P/100 uds

| | | | | | | |
|--------|--------|--------|--------|--------|--------|--------|
| | | | | | | |
| 051451 | 051452 | 051453 | 051454 | 051455 | 051456 | 051457 |

Marcaje



Marcador spray Raidex 400 mL

| | | | | | | |
|--------|--------|--------|--------|--------|--------|--------|
| | | | | | | |
| 051821 | 051822 | 051823 | 051824 | 051825 | 051826 | 051828 |



Marcador spray Raidex ovino 500 mL

| | | | |
|--------|--------|--------|--------|
| | | | |
| 051833 | 051835 | 051837 | 051839 |



Marcador spray Porcimarck 400 mL

| | | |
|--------|--------|--------|
| | | |
| 051827 | 051829 | 051831 |



Lápiz marcador

| | | |
|--------|--------|--------|
| | | |
| 051811 | 051815 | 051817 |



Lápiz marcador Raidex

| | | | |
|--------|--------|--------|--------|
| | | | |
| 051801 | 051802 | 051803 | 051804 |
| | | | |
| 051805 | 051807 | 051809 | |



Juego números pintura

| | |
|--------|--------|
| 8 cm | 14 cm |
| 051611 | 051615 |



Pintura lana 4 kg

| | | |
|--------|--------|--------|
| | | |
| 051617 | 051619 | 051621 |



Ref. 051618

Pintura lana 5 kg negra

IDENTIFICACIÓN

Sacabocados y tijeras



Sacabocados ovino

| | | | | |
|--------|--------|--------|--------|--------|
| | | | | |
| 051901 | 051903 | 051905 | 051907 | 051909 |



Ref. 051921
Tijera marcar recta estándar



Ref. 051923
Tijera marcar curva estándar



Ref. 051861
Mandil carnero nylon
60x30 cm



Ref. 200075
Tijera universal
multicorte 19 cm



Ref. 051925
Tijera marcar con lentilla estándar



| Arnés ovino | |
|-------------|--------|
| Cuero | Nylon |
| 051841 | 051843 |



| Pastilla arnés Raidex | | | |
|-----------------------|--------|--------|--------|
| Amarilla | Azul | Roja | Verde |
| 051851 | 051853 | 051855 | 051857 |



| Arnés toro | |
|------------|--------|
| Cuero | Nylon |
| 051845 | 051847 |

Collares y marcas



| Pulsera plástico P/5 uds | | | | | |
|--------------------------|--------|--------|--------|--------|--------|
| | ● | ● | ● | ● | ● |
| Vacuno | 051231 | 051232 | 051233 | 051234 | 051235 |
| Ovino | 051241 | 051242 | | 051244 | 051245 |



| Collar plástico ovino | | | | | |
|-----------------------|--------|--------|--------|--------|--------|
| ● | ● | ● | ● | ● | ● |
| 051201 | 051202 | 051204 | 051205 | 051206 | 051207 |



| Marca para collar nylon | | |
|-------------------------|--------|--------|
| | ● | ● |
| Ovino | 051261 | 051263 |
| Vacuno 5 cm | 051259 | |



| Collar nylon ovino 65 cm | | | | | |
|--------------------------|--------|--------|--------|--------|--------|
| ● | ● | ● | ● | ● | ● |
| 051211 | 051212 | 051214 | 051215 | 051217 | 051218 |



| Marca vacuno colgar | |
|---------------------|--------|
| ● | ● |
| 051281 | 051284 |



| Marca ovino colgar | |
|--------------------|--------|
| ● | ● |
| 051271 | 051274 |



| Brazalete velcro vacuno P/5 uds | | | |
|---------------------------------|--------|--------|--------|
| ● | ● | ● | ● |
| 051251 | 051252 | 051254 | 051255 |

IDENTIFICACIÓN

Tatuadores de tenaza

CHEVILLOT



Ref. 050234
Carácter Chevillot
8 mm nulo

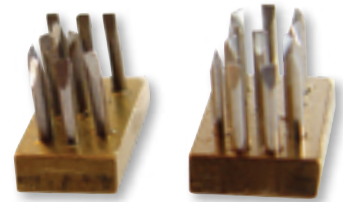

| Carácter Chevillot (nº/letra) | |
|-------------------------------|--------|
| 8 mm | 10 mm |
| 050237 | 050233 |

| Tatuador Chevillot | | |
|--------------------|------------|------------|
| Medida | 6 casillas | 7 casillas |
| 8 mm | | 050205 |
| 10 mm | 050203 | |



| | |
|-------|-------------|
| 10 mm | E S 1 2 3 |
| 8 mm | H U 1 2 3 4 |



Ref. 050249
Rueda recambio
Axamatic 10 caracteres



Ref. 050611
Tinta pasta negra 60 g



Ref. 050211
Tatuador Axa-287 7 casillas 5 mm



Ref. 050245
Carácter Axa-287
5 mm (nº/letra)



Ref. 050621
Tinta pasta negra bote 600 g

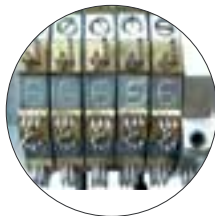

Ref. 050213
Tatuador Axamatic rotor 5 mm



Ref. 050247
Carácter fijo Axamatic
5 mm (nº/letra)



| Tinta bola 60 mL | |
|------------------|--------|
| Negra | Verde |
| 050601 | 050603 |

Martillos tatuadores



Ref. 050406
Martillo aluminio 14 casillas 20 mm



Ref. 050413
Carácter martillo 20 mm nº / letra



Ref. 050405
Martillo hierro 14 casillas 20 mm



Ref. 050651
Tampón tinta martillo



Nº. Reg.
02150-MUZ

Ref. 050631
Tinta negra Cheillot 1 litro



Ref. 050653
Tinta negra Raidex 1 litro

Nº. Reg.
02150-MUZ
ESPECIAL
MATADERO



Tinta alimentaria 1 litro

Roja

051995

Marrón

051997

MATERIAL GANADERO

Empujadores



Ref. 550005
Empujador Hot-Shot



Ref. 550023
Pila Hot-Shot P/6 uds

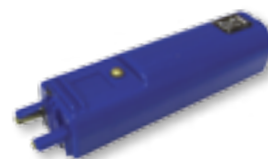

Ref. 550021
Motor Hot-Shot



Alargadera Hot-Shot

| | 34 cm | 60 cm | 85 cm | 100 cm | 130 cm | 160 cm |
|----------|--------|--------|--------|--------|--------|--------|
| Flexible | 550010 | 550011 | 550012 | | 550013 | |
| Rígida | | | | 550017 | 550018 | 550019 |



Bandeja guía porcino

| | |
|----------|-----------|
| 94x76 cm | 120x76 cm |
| 550041 | 550043 |



Ref. 11262
Empujador AniShock PRO batería



Alargadera flexible AniShock PRO

| | |
|-------|-------|
| 57 cm | 71 cm |
| 11263 | 11264 |



Ref. 11266
Batería AniShock PRO



Ref. 550045
Paleta arreadora porcino

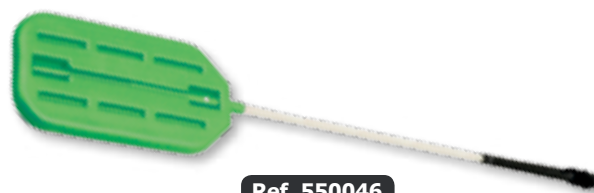

Ref. 550046
Paleta arreadora sonajero porcino 107 cm

Inmovilizadores



Ref. 550209
Traba correctora C/12 uds



Ref. 550211
Trabón para patas de cuero con cierre



Ref. 550213
Trabón para patas de nylon



Ref. 550217
Cinta nylon evitacoces Bovivet

Destetadores



Ref. 550569

Destetador aluminio con muelle



Ref. 550566

Antiteta plástico blanco



Ref. 550567

Antiteta plástico naranja



Ref. 550565

Antiteta plástico azul



Ref. 550571

Destetador aluminio con cierre



Ref. 550585

Tenaza para anilla destetadora



Anilla destetadora

| Pequeña | Mediana | Grande |
|---------|---------|--------|
| 550079 | 550081 | 550083 |

Narigones y abrebocas



Ref. 550543

Narigón con cierre HARMS



Ref. 550545

Narigón de muelle con protector



Ref. 550547

Narigón de muelle sin protector



Ref. 550549

Narigón para sujeción con cadena



Ref. 550561

Narigón para sujeción sin cadena



Ref. 550591

Abrebocas Bayer



Ref. 550562

Nariguera doble mango 44 cm



Ref. 550593

Abrebocas Shoupe

Anillas



Ref. 550539
Tenaza para anillas de giro 55 mm



| Anilla nasal de giro | | |
|----------------------|---------|---------|
| Material | Ø 55 mm | Ø 65 mm |
| Acero | 550531 | 550532 |
| Latón | 550535 | 550536 |



Ref. 550524
Tenaza para anillas toro



| Anilla toro latón | | | |
|-------------------|--------------|--------------|---------------|
| 50,5 Ø 8 mm | 59 Ø 8 mm | 57 Ø 9 mm | 65 Ø 11 mm |
| 550525 | 550526 | 550527 | 550528 |



| Anilla toro cromada | | |
|---------------------|--------|--------|
| 52-54 mm | 61 mm | 70 mm |
| 550521 | 550522 | 550523 |



Ref. 550519
Tenaza grapa cerdos



Ref. 550515
Tenaza anilla nasal cerdos



| Grapa cerdos P/100 uds | |
|------------------------|--------|
| 3 cm | 4 cm |
| 550517 | 550518 |



Ref. 550511
Anilla nasal cerdos niquelada



Ref. 550513
Anilla nasal cerdos cromada

Sujeción



| Mosquetón anilla giratoria | |
|----------------------------|--------|
| 20 mm | 30 mm |
| 550451 | 550452 |



Ref. 550453
Mosquetón antipánico



Ref. 550454
Mosquetón Tourillon
22x22 mm



| Mosquetón bombero | | | | |
|-------------------|--------|--------|--------|--------|
| 5 cm | 7 cm | 10 cm | 12 cm | 14 cm |
| 550445 | 550446 | 550447 | 550448 | 550449 |



Ref. 550458
Mosquetón universal



| Eslabón rápido | | | |
|----------------|--------|--------|--------|
| 5 cm | 6 cm | 7 cm | 8 cm |
| 550459 | 550460 | 550461 | 550462 |



Ref. 550235
Gancho pastor
acero niquelado



Ref. 550237
Gancho pastor
aluminio



| Collar nylon terneros amarre giratorio | | |
|--|--------|--------|
| Azul | Rojo | Verde |
| 550247 | 550248 | 550249 |



Ref. 550243
Collar sujeción
con cadena vacuno



| Cabezana nylon vaca | | | | |
|---------------------|--------|--------|--------|--------|
| Amarillo | Blanco | Rojo | Azul | Verde |
| 550261 | 550263 | 550265 | 550267 | 550269 |



Ref. 550501
Lazo cerdos sirga



Ref. 550508
Mini lazo cerdos



Ref. 550503
Lazo cerdos sin freno



Ref. 550505
Lazo cerdos con freno

MATERIAL GANADERO

Esquiladoras



Ref. 500071
Esquiladora ovino Heineger a corriente

Ref. 500051
Esquiladora bovino/equino Heineger batería



| | | |
|--------------|--------------|--------------|
| 13/4 dientes | 10/3 dientes | 13/4 dientes |
| 500077 | 500078 | 500079 |



Ref. 500073
Cabezal ovino Heineger



Ref. 500060
Batería esquiladora Heineger

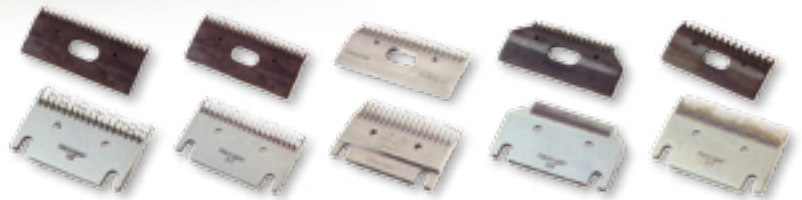

| | | | | |
|---------------|---------------|---------------|---------------|---------------|
| 18/23 dientes | 21/23 dientes | 19/21 dientes | 39/17 dientes | 31/15 dientes |
| 500054 | 500055 | 500056 | 500053 | 500057 |



Ref. 500001
Esquiladora Moser Styling III



Ref. 18561
Esquiladora Oster Pro 600i



Ref. 18265
Esquiladora Sonic



Ref. 500011
Esquiladora Arco Moser



Ref. 500003
Recambio cabezal Moser Styling III



Ref. 18563
Recambio cabezal Oster Pro 600i



Ref. 18161
Recambio cabezal Sonic



Ref. 500013
Batería recambio Arco Moser



Ref. 500015
Recambio cabezal Arco Moser

Esquiladoras



Ref. 500021
Esquiladora OSTER A5



Ref. 18548
Esquiladora
PowerPro Ultra



Nº 50
Corte 0,2 mm
500022



Nº 40
Corte 0,25 mm
500023



Nº 30
Corte 0,5 mm
500024



Nº 15
Corte 1,2 mm
500025



Ref. 500043
Escobilla limpieza
cabezal Oster



Nº 10
Corte 1,6 mm
500026



Nº 7
Corte 3,2 mm
500027



Nº 5
Corte 6,3 mm
500028



Nº 5/8
Corte 0,8 mm
500029



Ref. 500041
Spray lubricante
400 mL Oster



Nº 7/8
Corte 0,8 mm
500030



Nº 4
Corte 9,5 mm
500031



Nº 8 1/2
Corte 2,8 mm
500032



Nº 7F
Corte 3,2 mm
500033



Nº 5F
Corte 6,3 mm
500034



Nº 4F
Corte 9,5 mm
500035



Nº 9
Corte 2 mm
500036



Nº 10 largo
Corte 2,4 mm
500037



Ref. 500083
Aceite lubricante
100 mL

Cepillos/Rasquetas/Peines



Ref. 500403
Cepillo crines nylon



Ref. 500405
Cepillo nylon largo 9 cm



Ref. 500411
Cepillo plástico



Ref. 500441
Cepillo higiene para establo



Ref. 500445
Recambio cepillo higiene para establo



Ref. 500209
Tijera lana curva



Tijera lana doble resorte

| | |
|-------|-------|
| 29 cm | 34 cm |
|-------|-------|

| | |
|--------|--------|
| 500201 | 500205 |
|--------|--------|



Rasqueta 7 filas

| | |
|--------|--------|
| Vacuno | Equino |
| 500419 | 500421 |



Ref. 500425
Carda plana madera 120x170



Ref. 500427
Carda curva madera 155x130 mm



Ref. 3275
Almohaza plástico



Ref. 051921
Tijera marcar recta estándar



Ref. 051923
Tijera marcar curva estándar



Ref. 051925
Tijera marcar con lentilla estándar



Ref. 200075
Tijera universal multicorte 19 cm

Descornadores



Ref. 450401

Sierra descornar eléctrica



Ref. 450403

Disco Sierra descornar



Ref. 450405

Descornador con transformador eléctrico



Ref. 450407

Cabezal descornador
15 mm



Ref. 450409

Cabezal descornador
18 mm



Ref. 450415

Cabezal descornador
Kruuse 15 mm



Ref. 450413

Descornador a gas Kruuse MK2



Sirga descornar bovivet

| | |
|------------|-----------|
| 3,6 metros | 10 metros |
|------------|-----------|

450431

450433



Ref. 450435

Mangos sirga descornar



Ref. 450423

Descornador BUDEX recargable mechero



Ref. 103306

Pasta descornar Nethorn



Ref. 450437

Lápiz descornar modelo alemán



Ref. 450236

Descornador Elastrator XL Bander



Ref. 450237

Gomas Elastrator XL Bander
P/25 uds

MATERIAL GANADERO

Cortacolas



Ref. 450211
Cortacolas eléctrico



Ref. 450213
Cabezal cortacolas "media luna"



Ref. 450214
Cabezal cortacolas "recta"



Ref. 450215
Cabezal cortacolas "en V"

| Cortacolas a gas | | | |
|------------------|---------|--------------|-------------|
| Cortacolas | Cabezal | Cartucho gas | Aerosol gas |
| 450201 | 450203 | 450205 | 450207 |



Ref. 450217
Cortacolas corderos recto 19,5 cm



Ref. 450231
Tenazas gomas descolar

| Gomas descolar | |
|----------------|-----------|
| P/100 uds | P/500 uds |
| 450233 | 450235 |



Ref. 450221
Petro castración lechones

Descolmilladores



Ref. 450001
Alicate cortacolumillos acero niquelado



Ref. 450003
Alicate cortacolumillos acero inoxidable



Ref. 450011
Lima dental eléctrica con cable



Ref. 450013
Lima dental eléctrica batería



Ref. 450015
Protector plástico lima dental



Ref. 450019
Batería lima dental



Ref. 450017
Muela lima dental

Castración



| Pinza Burdizo | | | |
|---------------|--------|--------|--------|
| | 30 cm | 40 cm | 48 cm |
| Estándar | 450245 | 450249 | 450253 |
| Calidad A | 450247 | 450251 | 450255 |



| Pinza Burdizo 23 cm | |
|---------------------|-----------|
| Estándar | Calidad A |
| 450241 | 450243 |



| Emasculador HAUSMANN curvo | | |
|----------------------------|--------|--------|
| 18 cm | 26 cm | 31 cm |
| 450263 | 450267 | 450269 |



| Emasculador Sand 31 cm caballos | | |
|---------------------------------|--------|---------------|
| Recto | Curvo | Kit Recambios |
| 450279 | 450280 | 450281 |



Ref. 450271
Emasculador recto 19,5 cm



Ref. 450275
Emasculador Verboczy 30 cm



Ref. 450277
Emasculador Reimers 35 cm caballos

Pistolas de sacrificio



| Pistola sacrificio BLITZ | | |
|--------------------------|----------------|--------------|
| Pistola | Tubo + resorte | Kit limpieza |
| 601001 | 601005 | 601009 |



| Detonadores pistola BLITZ | | | |
|---------------------------|----------------|--------|---------------|
| Cerdos | Caballos/vacas | Toros | Grandes toros |
| 601011 | 601012 | 601013 | 601014 |



Ref. 601031
Pistola CASH especial



Ref. 601033
Detonador pistola CASH

MATERIAL GANADERO

Arreglo de cascos



400063

Legra hoja estrecha

| Derecha | Izquierda | Doble |
|---------|-----------|--------|
| 400063 | 400061 | 400065 |



400069

Legra hoja ancha

| Derecha | Izquierda | Doble |
|---------|-----------|--------|
| 400067 | 400069 | 400071 |



Ref. 400111

Máquina para cascos



Ref. 400075

Piedra afilar legras 13 cm



Ref. 400129

Cepillo con rascador



Ref. 400131

Rascador metálico



Ref. 400113

Disco abrasivo



Disco P6 Carbide 6 cuchillas

| 105 mm | 125 mm |
|--------|--------|
| 400119 | 400123 |



Disco de Tungsteno

| 115 mm | 125 mm |
|--------|--------|
| 400115 | 400117 |



Disco de aluminio

| 3 cuchillas | 6 cuchillas |
|-------------|-------------|
| 400125 | 400127 |

Pediluvios



Ref. 400135

Pediluvio bovino 180x90x10 cm

Ref. 850611

Pediluvio 90x60x4 cm



Ref. 400137

Bandeja pediluvio bovino 200x85x16 cm 200 litros



Ref. 850601

Bandeja pediluvio 50x35x9 cm

Arreglo de cascos



Ref. 400031
Tenaza articulada para cascos 41 cm



Ref. 400035
Tenaza lateral para cascos 60 cm



Ref. 400037
Tenaza de corte para cascos



Ref. 400039
Tenaza de talón para cascos



Ref. 400053
Maza para herrar



Ref. 400055
Martillo para herrar



Ref. 400045
Cuchilla para cascos 30 cm



Ref. 400047
Cuchilla para cascos BLACK BLUE 28 cm



Ref. 400049
Escofina para cascos en "S" 30 cm



Ref. 400051
Escofina para cascos plana 35 cm



Ref. 400251
Soporte cascos herraje HOOF-IT



Ref. 400041
Tenaza para herrar



Ref. 400043
Tenaza para cascos con dientes

Pezuñas ovino



| Cortauñas ovino acero 6 cm | |
|----------------------------|--------------|
| Hoja lisa | Hoja dentada |
| 400001 | 400003 |



| Cortauñas ovino Felco | |
|-----------------------|---------------------|
| Empuñadura normal | Empuñadura rotativa |
| 400005 | 400007 |



Ref. 400019
Legra ovino

MATERIAL GANADERO

Vendas



| Venda Vet-Plast P/10 uds | | |
|--------------------------|------------|-----------|
| 5x450 cm | 7,5x450 cm | 10x450 cm |
| 400181 | 400182 | 400183 |



| Venda Vet-Flex 450 cm P/10 uds | | | | |
|--------------------------------|--------|--------|--------|--------|
| C | 5 cm | 7,5 cm | 10 cm | 15 cm |
| ● | 400161 | 400164 | 400171 | 400177 |
| ● | 400162 | | 400172 | |
| ● | | 400163 | 400174 | |
| ● | | | 400173 | |
| ● | | | 400175 | |
| ● | | | 400176 | |



Ref. 400139

Venda alquitrán cascos
KROMBERG 25 m



Ref. 400143

Alquitrán para cascos
1 litro



| Venda Soft-Flex | | |
|-----------------|----------|----------|
| 4,5x500 cm | 9x150 cm | 9x500 cm |
| 400191 | 400192 | 400193 |



| Vendas de yeso P/2 uds | |
|------------------------|--------|
| Medida | Ref. |
| 5x270 cm | 201231 |
| 10x270 cm | 201233 |
| 15x270 cm | 201235 |
| 20x270 cm | 201237 |

Pezuñas bovino



| Demotec Easy Bloc | |
|-------------------|-----------------|
| 4 tratamientos | 12 tratamientos |
| 400081 | 400083 |

| Suela plástico Easy Bloc | |
|--------------------------|-----------|
| Derecha | Izquierda |
| 400093 | 400095 |



Ref. 400097
Líquido para Easy Bloc
250 mL

Ref. 400099
Polvo para Easy Bloc
500 mg



Ref. 400085
Demotec 95 14 tratamientos

Ref. 400091
Taco madera
DEMOTEC 90 y 95



| Demotec 90 | |
|----------------|-----------------|
| 2 tratamientos | 12 tratamientos |
| 400087 | 400089 |



Ref. 400101
Pistola aplicadora
Easy Bond III / Septicare



Ref. 400105
Cánula Easy Bond III
P/10 uds



Ref. 106650020
Cánula Septicare II
P/10 uds



Ref. 550207
Pinza sujetapatas



Ref. 400103
Cartucho Easy Bond III



Ref. 106650001
Cartucho Septicare II

MATERIAL GANADERO

Pezotomos/Cánulas mamarias



Ref. 350021
Vendaje ubres 6x500 cm



Ref. 350069
Dilatador pezones Bovivet P/20 uds



Ref. 350097
Bisturí Dyekjaer C/6 uds



Ref. 350093
Lanceta HUG



Ref. 350064
Cánula mamaria cono luer-lock
estéril P/100 uds



Ref. 350061
Cánula mamaria Columbus
C/20 uds



Ref. 350107
Cureta modelo Moses



Ref. 350105
Dilatador pezones



Ref. 350095
Evacuador HUG cabeza cortante



Ref. 350091
Evacuador 3 anillas 14 cm



Ref. 350089
Evacuador Danés
a cuchillas 18 cm



Ref. 350063
Cánula mamaria Bovivet C/10 uds



| Cánula mamaria oliva metal | | | |
|----------------------------|----------|--------|--------|
| Ø 2 mm | Ø 2,5 mm | Ø 3 mm | Ø 4 mm |
| 350081 | 350083 | 350085 | 350087 |



| Sonda mamaria metal L.L. inoxidable Ogival | |
|---|--------|
| 8 cm | 10 cm |
| 350077 | 350079 |

Ordeño



Ref. 350037
Separador de leche



Ref. 350035
Anulador de pezonería



Ref. 350055
Papel indicativo Bovivet
test mamitis 25 uds

Ordeño



| Filtro leche P/250 uds | | | | | |
|------------------------|--------|--------|--------|--------|--------|
| 250 mm | 320 mm | 450 mm | 530 mm | 620 mm | 820 mm |
| 350214 | 350211 | 350213 | 350212 | 350215 | 350216 |



Ref. 350217
Filtro de leche disco
Ø 230 mm C/200 uds



Ref. 350045
Paños de algodón
para ubres P/10 uds



Ref. 350025
Vaso desinfección
pezones sin retorno



Ref. 350027
Vaso desinfección
espuma



Ref. 350207
Pistola lavado
multusos



Ref. 350205
Termómetro para
leche con protector



Ref. 15385
Manguitos ordeño
P/2 uds



Ref. 350041
Toallitas desinfección
pezones P/800 uds



Ref. 350042
Recarga toallitas
B/800 uds



Ref. 350251
Pesador de calostro

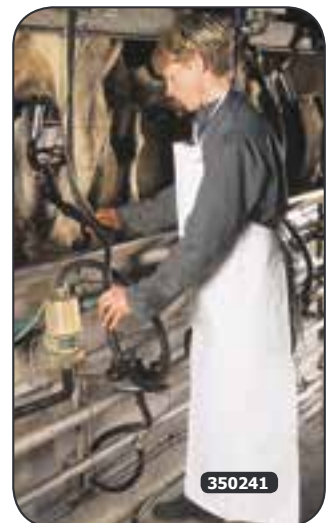

350241

| Delantal ordeño | | |
|-----------------|--------|--------|
| Azul | Blanco | Verde |
| 350239 | 350241 | 350243 |



Ref. 550219
Pinza sujeta colas

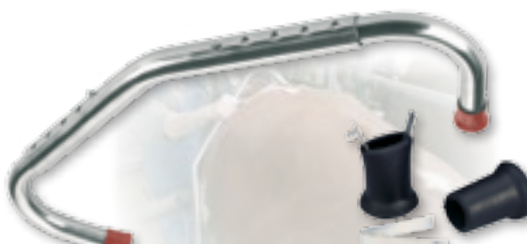

Ref. 550201
Traba evitacoces

Ref. 550203
Kit traba evitacoces

MATERIAL GANADERO

Sondas esofágicas/Trocares



| Sonda esofágica THYGSEN | | | |
|-------------------------|--------|--------|--------|
| | Sonda | Cono | Asa |
| 18 x 1800 mm (vacas) | 600409 | 600413 | 600415 |
| 12 x 1200 mm (terneros) | 600411 | 600414 | |



| Sonda esofágica | |
|-----------------|-----------------------|
| 150 cm vacuno | 120 cm terneros/ovino |
| 600401 | 600403 |



Ref. 600407
Abrebocas madera



| Sonda Bovivet | |
|---------------|----------|
| Rígida | Flexible |
| 600321 | 600323 |

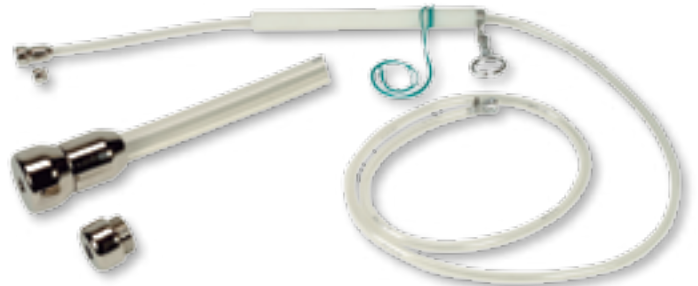

Ref. 190180
Sistema estomacal Probang Mark II Bovivet



| Sonda nasoesofágica EQUIVET | | | |
|-----------------------------|------------|------------|------------|
| 9x2100 mm | 13x2700 mm | 16x2700 mm | 19x3000 mm |
| 600431 | 600432 | 600433 | 600434 |



Ref. 190190
Bomba estomacal Mark II Bovivet



Ref. 190130
Bomba gástrica Equivet



Ref. 600451
Trocar de plástico BUFF



| Trocar mango madera | | | |
|---------------------|-------------------|-----------------|----------------|
| | 7x120 mm terneros | 10x150 mm vacas | 4x100 mm ovino |
| Trocar | 600453 | 600457 | 600461 |
| Cánula recambio | 600455 | 600459 | 600463 |



| Trocar metálico | | |
|-----------------|-------------------|----------------|
| | 7x120 mm terneros | 4x100 mm ovino |
| Trocar | 600465 | 600469 |
| Cánula recambio | 600467 | 600471 |

Partos



Ref. 300401
Ayudapartos modelo americano

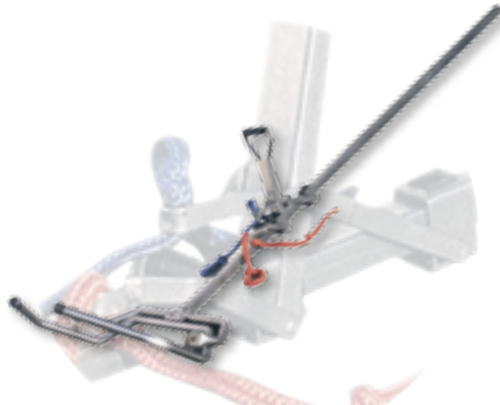

| Ayudapartos modelo VINK | |
|-------------------------|--------------|
| Vacuno leche | Vacuno carne |
| 300403 | 300405 |



Ref. 300421
Lazo extracción corderos



Ref. 300413
Cuerda ayudapartos universal P/2 uds



Ref. 300431
Reanimador terneros



Ref. 300445
Arnés elevador vacas



Ref. 300443
Elevador vacas Vink



Ref. 300441
Elevador vacas



Ref. 32-01
Pelvímetro novillas



Ref. 300655
Clamp para cordón umbilical



Ref. 300631
Prolapso para vacas nylon

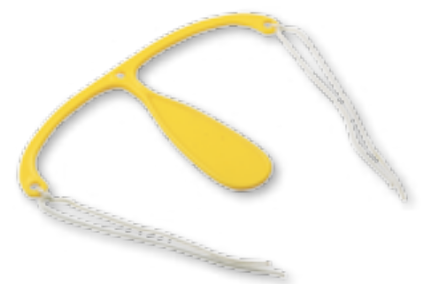

Ref. 300635
Prolapso ovino plástico

Cubos/Biberones/Tetinas



Ref. 600201
Cubo tetón vacuno
7 litros 1 salida



Ref. 600203
Cubo tetón vacuno
8 litros 1 salida



Ref. 600253
Cubo ovino 8 litros
5 tetinas



Ref. 600255
Cubo ovino rectangular
6 litros 5 tetinas



Ref. 600231
Tetina vacuno
caucho



Ref. 600239
Tetina vacuno caucho
cubo tetón 8 litros



Ref. 600235
Tetina vacuno roja
tubo tetón 8 litros



Ref. 600237
Tetina vacuno blanca
cubo tetón 8 litros



| Tetina cubo ovino | |
|-------------------|--------|
| Roja | Caucho |
| 600273 | 600275 |



Ref. 600271
Tetina caucho
cubo/biberón ovino



| | Biberón vacuno | Soporte biberón |
|----------|----------------|-----------------|
| 2 litros | 600211 | 600221 |
| 3 litros | 600213 | 600222 |



Ref. 600261
Biberón ovino
1 litro



Ref. 600263
Biberón corderos
500 cc



Ref. 600265
Botella calostro ovino

Ref. 600267
Repuesto sonda calostro



Ref. 600283
Tetina ovino botella



| Tetina biberón 2 y 3 litros | | |
|-----------------------------|--------|----------------|
| Roja | Blanca | Caucho natural |
| 600241 | 600243 | 600245 |



Ref. 600279
Tetina roja biberón
ovino 1 litro



Ref. 600281
Tetina biberón
500 c.c.



Ref. 600247
Tetina flotante
vacuno



Ref. 600249
Recambio tetina
flotante vacuno

Imanes



| Aplicador bolos | |
|-----------------|-------------------|
| Boquilla grande | Boquilla estrecha |
| 600449 | 600450 |



Ref. 600441
Imán esofágico
Bovivet



Ref. 600443
Imán esofágico
Bovimini



| Introductor imanes | | |
|--------------------|------------------|----------------|
| Bovivet metal | Bovivet plástico | Bovimini metal |
| 600445 | 600446 | 600448 |

Cuadra



| Librador galvanizado | |
|----------------------|--------|
| 1,5 kg | 2 kg |
| 601601 | 601603 |



| Librador grano plástico blanco | | |
|--------------------------------|--------|--------|
| 1 kg | 1,5 kg | 2 kg |
| 601611 | 601613 | 601615 |



| Librador aluminio | |
|-------------------|--------|
| 1 kg | 2 kg |
| 601607 | 601609 |



| | Rastrillo curvo | Goma recambio |
|-------|-----------------|---------------|
| 55 cm | 601401 | 601405 |
| 75 cm | 601403 | 601407 |



Ref. 601425
Cepillo PVC 60 cm

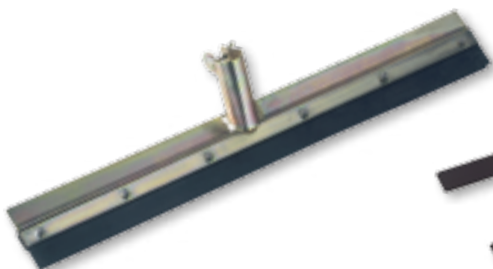

Ref. 601409
Rastrillo recto 60 cm



Ref. 601411
Goma recambio
rastrillo recto 60 cm



Ref. 601413
Mango madera
rastrillo



Ref. 601421
Pala aluminio



Ref. 601423
Pala plástico

Lámparas



| Lámpara IR PHILLIPS blanca | |
|----------------------------|--------|
| 150 W | 250 W |
| 601805 | 601807 |



| Refractor cuarzo | | |
|------------------|--------|--------|
| | Blanca | Roja |
| 175 W | 601825 | 601827 |
| 250 W | 601829 | 601831 |



| Bombilla cuarzo | |
|-----------------|--------|
| 175 W | 250 W |
| 601841 | 601843 |



| Lámpara IR PHILLIPS roja | |
|--------------------------|--------|
| 150 W | 250 W |
| 601809 | 601811 |



Ref. 601821
Protector halógeno para bombilla cuarzo



Ref. 601801
Protector lámparas infrarrojos con economizador

Bombas dosificadoras



| Dosatron 1 a 1500 l/hora | |
|--------------------------|---------------------|
| D-200 RE (0,2 al 2%) | D-25 RE2 (3 al 10%) |
| 800005 | 800009 |



Ref. 800011
Bomba eléctrica (0,03 al 3 l/h) caudal fijo



Ref. 800013
Bomba eléctrica (0,03 al 3 l/h) caudal variable

Bebederos vacuno



| Bebedero vacuno acero | | |
|-----------------------|--------------|----------------|
| Bebedero | Válvula rec. | Brida fijación |
| 800201 | 800203 | 800204 |



| Bebedero vacuno | | |
|-----------------|--------------|----------------|
| Bebedero | Válvula rec. | Brida fijación |
| 800210 | 800211 | 800212 |



| Bebedero Suevia bovino y equino | | |
|---------------------------------|------------------|----------------|
| Bebedero | Válvula + muelle | Brida fijación |
| 800220 | 800221 | 800222 |

Bebederos ovino



Ref. 800235
Bebedero nivel constante
2 litros



Ref. 800236
Bebedero nivel constante
3 litros



Ref. 6410174
Boya bebedero ovino 3/8



Ref. 800237
Boya bebedero
nivel constante



Ref. 800240
Bebedero Suevia ovino

Bebederos aves/Chupetes



| Bebederos aves plástico con asa | | |
|---------------------------------|-----------|-----------|
| 5 litros | 10 litros | 15 litros |
| 800301 | 800303 | 800305 |



Ref. 800311
Bebedero aves plástico
con pie 30 litros



Consultar
Chupetes
(varios modelos y materiales)

MATERIAL GANADERO

Medición y control



Ref. 600851
Cabezal pesaje
EW6



Ref. 600852
Cabezal pesaje
EW5



Ref. 600861
Barras de pesaje



Ref. 600881
Plataforma desmontable

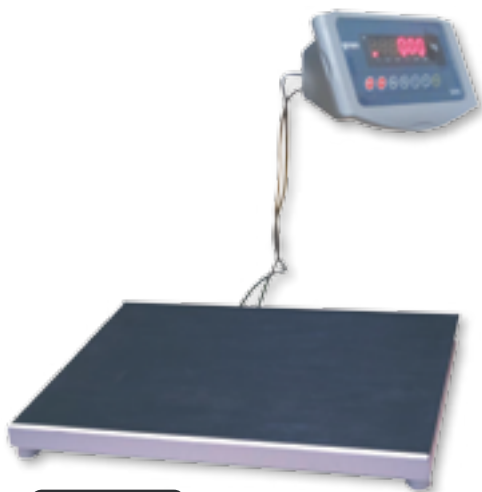

Ref. 600854
Báscula completa



| Dinamómetro | | |
|---------------|----------------|---------------|
| 5 kg (20 g) | 10 kg (50 g) | 25 kg (100 g) |
| 600801 | 600803 | 600805 |
| 50 kg (200 g) | 100 kg (500 g) | 250 kg (1 kg) |
| 600807 | 600809 | 600811 |



600813
600815

600817
600819

| Peso electrónico | | | |
|------------------|--------|--------|--------|
| 25 kg | 50 kg | 100 kg | 150 kg |
| 600813 | 600815 | 600817 | 600819 |



Ref. 600831
Cinta pesaje cerdos y vacas



Ref. 600611
Pluviómetro



Ref. 600615
Higrómetro



Ref. 600821
Contador manual



Ref. 600601
Termómetro ambiente



Ref. 600603
Termómetro ambiente
MAXI-MINI digital

Jaulas/Cepos/Exterminadores



| Exterminador insectos eléctrico | | | |
|---------------------------------|--------|--------|--------|
| 15 W | 30 W | 40 W | 60 W |
| 601201 | 601203 | 601205 | 601207 |



| Trampa ratones curva | |
|----------------------|--------|
| 23 cm | 40 cm |
| 601225 | 601227 |



Ref. 601241
Portacebos BETA



Ref. 601243
Portacebos PETI



601217

| Cebo SUPERCAT | |
|---------------|--------|
| Ratones | Ratas |
| 601215 | 601217 |



| Cepo madera | |
|-------------|--------|
| Ratones | Ratas |
| 601221 | 601219 |



Ref. 601227
Trampa ratones recta 40 cm

Sulfatadoras

MATABI



Ref. 600001
Pulverizador Berry
1,5 litros



Sulfatadora Style
5 litros 7 litros
600003 600005



Ref. 600011
Sulfatadora Polita
7 litros



Ref. 600007
Sulfatadora Supergreen
12 litros



Ref. 600013
Sulfatadora Super Agro
20 litros



Ref. 600009
Sulfatadora Evolution
16 litros

MATERIAL GANADERO

Pastores batería y solares



Ref. 650601
Pastor Batería Rb 880 30 km



Ref. 651003
Pila alcalina 9 V
120 amperios



Ref. 650401
Pastor pila Rb 50 7 km



Ref. 651001
Pila alcalina 9 V
55 amperios



650801

| Panel solar monocrystalino 10 W | |
|---------------------------------|-------------|
| Con pie | Con soporte |
| 650801 | 650803 |



Ref. 651009
Acumulador 12 V
7.2 amperios



Ref. 814098
Pastor viper S-500 5 km

Pastores eléctricos



Ref. 650207
Pastor red Rb 85 10 km



Ref. 650217
Pastor red S200 40 km



Ref. 650219
Pastor red S400 100 km



Ref. 650221
Pastor red S500 120 km

Cinta e hilo

80 kg



Ref. 650501
Hilo 6 mm inox 3x0,15
R/200 m

80 kg



Ref. 650503
Hilo 6 mm inox 3x0,15
R/400 m

80 kg



Ref. 650505
Hilo 6 mm inox 6x0,15
R/200 m

80 kg



Ref. 650507
Hilo 6 mm inox 6x0,15
R/400 m

140 kg



Ref. 650509
Cordón 6 mm mono inox
6x0,15 R/200 m

115 kg



Ref. 650511
Cinta 12 mm inox
4x0,20 / 1x0,15 R/200 m

140 Kg



Ref. 650513
Cinta 20 mm inox
6x0,20 / 1x0,15 R/200 m

180 kg



Ref. 650515
Cinta 40 mm inox
8x0,20 / 1x0,15 R/200 m



Ref. 651305
Cinta especial Jabalí 13 mm
R/500 m



Ref. 651631
Cable aluminio R/400 m



Ref. 651621
Cable acero galvanizado
R/250 m



Ref. 651623
Cable acero galvanizado
R/500 m

Aisladores



Aislador cola lechón
P/50 uds

Ø 10 mm Ø 12 mm

652023 652025



Ref. 652027

Aislador cola lechón
Ø 19 mm P/25 uds



Ref. 652033

Aislador hilo/metal
P/25 uds



Ref. 652037

Aislador hilo/metal 80 mm
P/25 uds

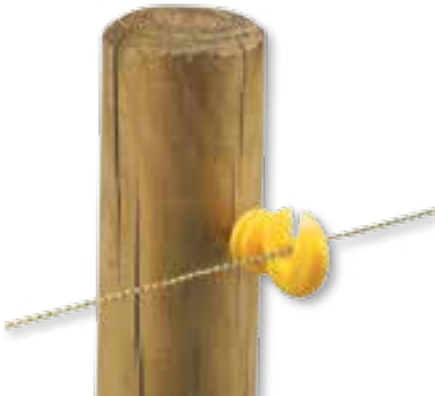

Aislador redondo
madera hilo P/25 uds

Negro Amarillo

652009 652011



Ref. 652005

Aislador super rb madera
cinta/cable/hilo P/25 uds



Ref. 652021

Aislador madera cinta
con clavos P/25 uds



Ref. 652019

Aislador esquina madera cinta
P/10 uds



Ref. 652017

Aislador esquina madera hilo
P/10 uds



Ref. 652031

Aislador madera cinta
P/25 uds



Ref. 652007

Aislador super rb piqueta
cinta/cable/hilo P/25 uds



Ref. 652035

Aislador doble P/2 uds

Piquetas y mallas



Ref. 651201

Malla ovejas 0,90 x 50 m

Ref. 651231

Piqueta malla ovejas



Ref. 651801

Piqueta fibra de vidrio
1,15 m



Ref. 651803

Piqueta fibra de vidrio
1,60 m



Ref. 651805

Piqueta plástico
4 aisladores 0,73 m



Ref. 651807

Piqueta plástico
7 aisladores 1,05 m



Ref. 651205

Malla cabras 1,06 x 50 m

Ref. 651233

Piqueta malla cabras



Ref. 651809

Piqueta plástico
8 aisladores 1,50 m



Ref. 651811

Piqueta plástico
1,05 m Ø 19 mm



Ref. 651813

Piqueta plástico estribo
7 aisladores 1,10 m



Ref. 651815

Piqueta plástico estribo
8 aisladores 1,40 m

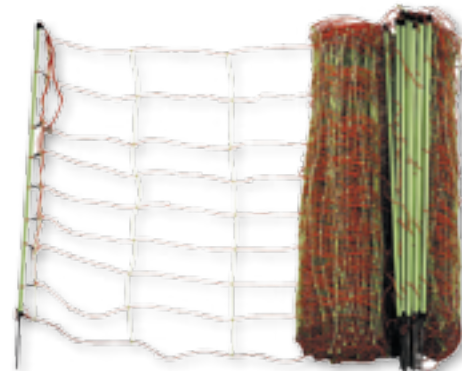

Ref. 651203

Malla ovejas kombi 0,90 x 50 m



Ref. 651825

Base piqueta malla

Accesorios pastores



Ref. 652241
Cierre tensor hilo



Ref. 652245
Cierre tensor completo



Ref. 652261
Adaptador para taladro



652231

Racord cinta P/5 uds

| | |
|--------|--------|
| 20 mm | 40 mm |
| 652231 | 652233 |



Ref. 652239
Tensor cinta P/5 uds



Ref. 652238
Racord cordón
acero inoxidable P/5 uds



Ref. 652235
Racord cinta regulable
20 mm P/5 uds



Ref. 652201
Recogedor euro-2000
para 500 m



Ref. 652209
Recogedor gran modelo
para 3000 m

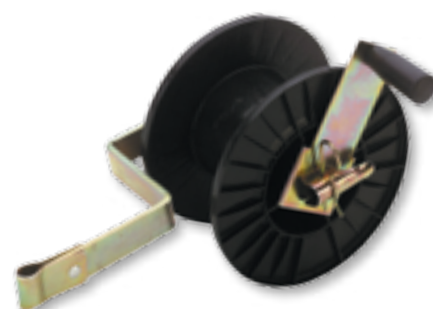

| Recogedor | | |
|-----------|--------|--------|
| 17 cm | 24 cm | 26 cm |
| 652203 | 652205 | 652207 |



Ref. 652223
Piqueta toma tierra 1 m

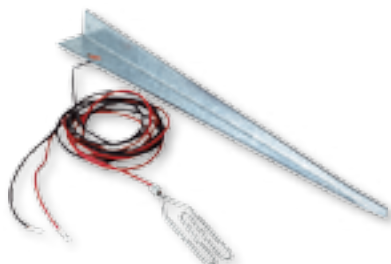

Ref. 652221
Piqueta toma tierra corta

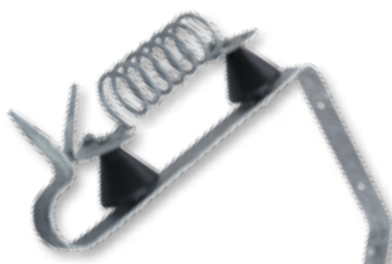

Ref. 652243
Pararrayos



Ref. 652255
Cable conexión
toma tierra y cercados



Ref. 652257
Interruptor universal
para cerca



Ref. 652251
Tester pastor eléctrico

Piensos y suplementos

VERRACHOC

PIENSO COMPLEMENTARIO PARA VERRACOS



Ref. 5001544
VERRACHOC 5 kg

- Aumenta la calidad y cantidad del semen
- Reduce formas anormales en el esperma
- Evita procesos inflamatorios a nivel testicular
- Mejora los aplomos
- Con L-Carnitina, biotina, levaduras y complejo de vitaminas

METASOL

COMPLEJO QUELATADO DE OLIGOELEMENTOS



Ref. 5001529
METASOL 1 litro

- La solución para problemas locomotores en avicultura
- Previene fracturas de cabeza de fémur
- Promueve la vascularización y estimula el sistema inmune
- Mejora la rentabilidad

SEDAROM

ATENUANTE DE LAS REACCIONES DE ESTRÉS



Ref. 5001565
SEDAROM 1 litro

- Atenuación de las reacciones de estrés, debido al transporte, calor, superpoblación en porcino y en aves
- Facilita el manejo de los animales
- Contiene una mezcla de sustancias aromáticas naturales, extractos hidro-alcohólicos de vegetales de valeriana, pasionaria...

ACIDOTRUIE

ALIMENTO MINERAL PARA ACIDIFICAR LA ORINA
Y REDUCIR EL TIEMPO DE PARTO EN CERDAS



Ref. 5001566
ACIDOTRUIE 10 kg

- Reducción del riesgo de infecciones urinarias
- El aporte de calcio y magnesio facilitan el parto
- Composición: cloruro de magnesio sobre soporte vegetal, calcio, fósforo

BOLOS NUTRICIONALES

CARENCIAS NUTRICIONALES



- Amplia gama de bolos nutricionales para trastornos nutricionales.

NATURAL CARBON CLAY

TRASTORNOS DIGESTIVOS



Ref. 400271
NCC Jeringa 60 ml

- Caolín en pasta para tratamientos de los problemas digestivos en terneros, corderos y lechones

Higiene y desinfección

SPECTRAGEN DESINFECTANTE CONCENTRADO DE NUEVA GENERACIÓN

Desinfectante líquido concentrado para el entorno ganadero a base de amonios cuaternarios y glutaraldehído.
Aplicación: pediluvio, remojo, pistola, termonebulización (1 ml por m³ según norma NFT 72-281)

- Homologado según normas europeas
- Bactericida al 0,2% (Norma EN 14349)
- Virucida al 0,6% (Norma EN 14675)
- Fungicida al 1% (Norma EN 13697)
- Efectivo en cualquier tipo de superficie
- Activo desde 4°C



N° Reg.
03645-P

Ref. 850006

Spectragen 5 litros

Ref. 850008

Spectragen 20 litros

Ref. 850010

Spectragen 60 litros

Ref. 850012

Spectragen 200 litros

OXYPUR LIMPIEZA Y DESINFECCIÓN DE LOS CIRCUITOS DE AGUA



Ref. 850043

Oxypur 24 kg

Ref. 850045

Oxypur 220 kg

- Limpia, desinfecta, desincrusta, antisarro, alguicida
- Mejora los rendimientos
- Peróxido estabilizado al 50%

OCLINE LIMPIEZA Y DESINFECCIÓN DE LOS CIRCUITOS DE AGUA



Ref. 850815

Ocline 5 litros

- Higieniza el agua de bebida y elimina el biofilm de las cañerías
- No es agresivo con los tratamientos en agua (vitaminas, antibióticos, minerales...)
- Actúa a cualquier pH, TH. Floculante de metales, ideal para aguas pesadas

Secantes de camas

DELTASEC HIGIENIZANTE DE CAMAS SUPERABSORBENTE (3 litros por kg)



N° Reg.
0652-H

Ref. 850821

Deltasec 25 kg

- Seca, purifica la atmósfera, repele insectos, mejora el bienestar animal
- Biodegradable
- Respeto el medio ambiente

TALC LAPINS HIGIENIZANTE DEL NIDO DE LOS GAZAPOS



N° Reg.
0657-H

Ref. 850811

Talc lapins 4 kg

- Seca, cicatriza, desinfecta el nido
- Efectivo a dosis muy bajas (15 g por nido)
- No irrita, no obstruye la nariz del gazapo

Crema ubres

CAI-PANmint

Ubres sanas

Bajo recuento de células somáticas

Alta producción de leche

CAIPAN

CREMA TONIFICANTE DE UBRES A BASE DE MENTA JAPONESA

- Calma, tonifica y previene la mastitis
- Sin período de supresión
- Elimina edemas e inflamación, de acción rápida
- Ingredientes naturales, sin antibióticos

CAI-PANmint

EL ORIGINAL



N°. Reg. 0156-H



Ref. 350111
Caipan 400 mL



Ref. 350113
Caipan 500 mL



Ref. 350115
Caipan 2500 mL



Ref. 350117
Dispensador con cadena

CAI-PANmint es un producto totalmente natural especialmente formulado para su uso sobre las ubres



CAI-PANmint es un producto muy rentable, dado el bajo costo del tratamiento y la eficacia demostrada del mismo

CAI-PANmint facilita la limpieza de las ubres, ayudando a mantener unas adecuadas condiciones de higiene, además de tener un efecto calmante y tonificante sobre las mismas

CAI-PANmint ayuda a mantener unos buenos niveles de producción al mantener las ubres en buen estado

Lubricación



| Toallitas desinfección | |
|------------------------|---------|
| 150 uds | 900 uds |
| 6410337 | 6410339 |



Ref. 150163
Lubrinet 1 litro



| Gel Bovinet | | |
|-------------|---------|----------|
| 500 mL | 1 litro | 5 litros |
| 300453 | 300454 | 300455 |

Índice de productos

A

| | |
|--------------------------------|-------|
| Abrebocas | 119 |
| Aceite de inmersión | 30 |
| Acoplador aguja | 100 |
| Agitador magnético | 32 |
| Agitador rotativo | 32 |
| Agua estéril | 6, 21 |
| Agujas de bisel OPU | 48 |
| Agujas de sutura | 80-82 |
| Agujas desechables | 99 |
| Agujas hipodérmicas | 99 |
| Aisladores | 144 |
| Alargadera Hot-Shot | 118 |
| Alfombrilla de caucho | 20 |
| Algodón hidrófilo | 87 |
| Alimento mineral | 147 |
| Alquitrán para cascos | 130 |
| Analizador de semen | 26 |
| Anilla toro | 120 |
| Anulador de pezonera | 132 |
| Aplicador bolos | 137 |
| Arnés ovino | 114 |
| Aspic para pajueta ovina | 11 |
| Aspirador manual de pipetas | 30 |
| Atenuante reacciones de estrés | 147 |
| Autoclave | 33 |
| Ayudapartos | 135 |

B

| | |
|-----------------------------|-----|
| Balanza portátil | 33 |
| Balanza precisión | 33 |
| Bandeja guía porcino | 118 |
| Bandeja pediluvio | 128 |
| Bandeja suelo Cuniflex | 18 |
| Baño maría | 33 |
| Baño ultrasonidos | 33 |
| Barras de pesaje | 140 |
| Báscula completa | 140 |
| Bata desechable visita | 104 |
| Bata partos | 104 |
| Bebedero aves | 139 |
| Bebedero ovino | 139 |
| Bebedero vacuno | 139 |
| Biberón ovino | 136 |
| Biberón vacuno | 136 |
| Biocongelador embriones | 49 |
| Bisturi Dyekjaer | 132 |
| Bobina funda vagina equino | 12 |
| Bolos nutricionales | 147 |
| Bolsa de medio flushing | 46 |
| Bolsa dilución porcino | 23 |
| Bolsa GTB 80 ml | 23 |
| Bolsa recogida muestras | 75 |
| Bolsa semen porcino | 23 |
| Bomba aspiración con filtro | 37 |
| Bomba aspiración ovocitos | 48 |
| Bomba eléctrica | 138 |
| Bomba estomacal | 134 |
| Bomba gástrica | 134 |
| Bombilla cuarzo | 138 |
| Bote Duquesa con obturador | 75 |
| Bote inseminación | 24 |
| Bote muestras estéril | 75 |
| Bote muestras leche | 75 |
| Botella calostro | 136 |
| Brazaletes velcro vacuno | 115 |

C

| | |
|-------------------------------|-----|
| Cabezal pesaje | 140 |
| Cabezana vaca | 121 |
| Cadena obstetricia | 90 |
| Cajas Petri | 51 |
| Calentador de inyectoras | 8 |
| Calentador de tubos | 48 |
| Calibre pajuetas | 36 |
| Calza azul desechable | 106 |
| Calza toma de muestras | 75 |
| Cámara Burkner | 29 |
| Cámara de Neubauer | 29 |
| Cámara OPTIKAM | 28 |
| Cámara Thoma | 29 |
| Camisas sanitarias | 8 |
| Canister | 41 |
| Cánula bucal luer-lock | 100 |
| Cánula conejos curva | 19 |
| Cánula conejos recta corta | 19 |
| Cánula especial pava | 16 |
| Cánula mamaria | 132 |
| Cánulas conejos recta | 18 |
| Cánulas monodosis flexibles | 19 |
| Capilares estériles embriones | 47 |
| Capilares vidrio | 47 |
| Capuchón estéril LUER | 14 |
| Carácter Chevallot | 116 |
| Carácter martillo | 117 |
| Carda curva | 124 |
| Catéter extensible embriones | 44 |
| Catéter uterino | 91 |

| | |
|------------------------------------|-----|
| Catéter Venocan | 100 |
| Centrífuga | 32 |
| Cepillo con rascador | 128 |
| Cepillo crines | 124 |
| Cepillo higiene | 124 |
| Cepillo PVC | 137 |
| Chaqueta partos | 105 |
| Chupetes | 139 |
| Cierre tensor | 146 |
| Cinta e hilo | 143 |
| Cinta pesaje | 140 |
| Cinturón Innovia cerdas | 24 |
| Citómetro de flujo | 26 |
| Clamp para cordón umbilical | 135 |
| Clasificador de huevos salmónidos | 15 |
| Collar terneros | 121 |
| Collar nylon ovino | 115 |
| Collar plástico ovino | 115 |
| Collectis | 20 |
| Congelación del semen | 38 |
| Consumibles Lynx disolvente | 36 |
| Consumibles Lynx tinta | 36 |
| Contador manual | 30 |
| Contador pajuetas | 39 |
| Contenedor agujas | 100 |
| Control de la temperatura | 68 |
| Control de trastornos alimentarios | 68 |
| Control del celo | 68 |
| Control del parto | 68 |
| Cortacolas | 126 |
| Cortacolmillos | 126 |
| Cortador de pajuetas | 8 |
| Cortauñas ovino | 129 |
| Crema de ubres | 149 |
| Crotal BOTÓN Allflex | 111 |
| Crotal electrónico HDX | 110 |
| Crotal JÚNIOR Allflex | 111 |
| Crotal MAXI Allflex | 111 |
| Crotal MEDIANO Allflex | 111 |
| Crotal SÉNIOR Allflex | 111 |
| Crotales ADN | 109 |
| Cuba nitrógeno MCA | 39 |
| Cubetas fotómetros | 27 |
| Cubierta estéril para cirugía | 86 |
| Cubierta estéril y absorbente | 86 |
| Cubiletas | 41 |
| Cubo ovino | 136 |
| Cubo tetón | 136 |
| Cubre objetos | 29 |
| Cubrebotas con goma | 106 |
| Cuchilla especial cesáreas | 82 |
| Cuchilla para cascos | 129 |
| Cuerda ayudapartos | 135 |
| Cutímetro | 97 |

D

| | |
|---------------------------|-----|
| Delantal ordeño | 133 |
| Delantal para partos | 105 |
| Demotec | 131 |
| Descongelador pajuetas | 8 |
| Descornador a gas | 125 |
| Descornador eléctrico | 125 |
| Desinfectante concentrado | 148 |
| Destetadores | 119 |
| Digestor Trichomatic | 74 |
| Dilatador cervical | 44 |
| Dilatador pezones | 132 |
| Dilutor | 27 |
| Diluyente aves | 16 |
| Diluyente en canino | 19 |
| Diluyente peces | 15 |
| Diluyentes cunicultura | 18 |
| Diluyentes porcino | 21 |
| Diluyentes semen bovino | 6 |
| Diluyentes semen equino | 14 |
| Diluyentes semen ovino | 10 |
| Dinamómetro | 140 |
| DipQuick kit | 31 |
| Disco de tungsteno | 128 |
| Dosatron | 138 |
| Dosificador bucal | 92 |
| DryShipper 3.0 | 42 |

E

| | |
|-----------------------------------|--------|
| Ecógrafos | 52-65 |
| Electrobisturí | 89 |
| Electro-eyaculadores bovino/ovino | 5 |
| Elevador canister | 41 |
| Elevador vacas | 135 |
| Emasculador | 127 |
| Embriotomo | 90 |
| Empujador Hot-Shot | 118 |
| Endoscopios | 66, 67 |
| Eosina | 30 |
| Eosina-Nigrosina | 30 |
| Equitainer con kit | 14 |
| Escobillón | 75 |
| Escobillón limpieza | 75 |

| | |
|---------------------------------|---------|
| Escofina | 129 |
| Escurreidor en acero | 75 |
| Espéculo | 73 |
| Espéculo aves | 17 |
| Espéculo IMV | 11 |
| Espéculo vaginal ovejas | 73 |
| Espéculo vaginal yegua/vaca | 73 |
| Esquiladora | 122,123 |
| Estufa secado | 33 |
| Evacuador | 132 |
| Exterminador insectos eléctrico | 141 |

F

| | |
|--------------------------------|-----|
| Filtro en copa EMCON embriones | 45 |
| Filtro EZ para sondas Foley | 45 |
| Filtro leche | 133 |
| Filtro semen equino | 12 |
| Filtros 230 mm | 20 |
| Fonendoscopio | 73 |
| Fotómetro | 27 |
| Frasco lavador | 75 |
| Funda vagina Missouri | 13 |

G

| | |
|---------------------------|-------------|
| Gafas V-MAXX | 106 |
| Gancho articulado | 90 |
| Gancho ocular | 90 |
| Gancho para partos | 90 |
| Gancho pastor | 121 |
| Gasa estéril | 87 |
| Gasa no estéril | 87 |
| GEDIS | 22 |
| Gel Bovivet | 24, 91, 149 |
| Gel estéril Priority Care | 12, 51 |
| Gel Lubricante B-LUBE | 5, 12, 24 |
| Gel Lubrinet | 24, 149 |
| Gel Priority Care | 12, 51 |
| Generador de nitrógeno | 43 |
| Geolocalización | 70 |
| Gomas descolar | 126 |
| Gorro circular | 106 |
| Gotero | 86 |
| Gradilla | 31 |
| Grapadora desechable | 82 |
| Guante polytactyl estéril | 51 |
| Guantes | 102, 103 |
| Guantes látex | 25 |
| Guantes nitrilo | 25 |
| Guantes supersensitivos | 8,14 |
| Guantes vinilo | 25 |

H

| | |
|-----------------------|-----|
| Higienizante de camas | 148 |
| Higienizante del nido | 148 |
| Higrómetro | 140 |
| Hisopo Equivet | 13 |
| Hisopo estéril | 75 |
| Histeroscopia | 19 |
| Hoja bisturí | 89 |

I

| | |
|--------------------------|-----|
| Iluminación Lumistil | 11 |
| Imán esofágico Bovivet | 137 |
| Imperdible vaginal | 90 |
| Impresora de pajuetas | 36 |
| Incubador Planer BT37 | 48 |
| Inglete plástico | 41 |
| Inyector ovino | 11 |
| Inyector pajuetas 1,2 ml | 16 |
| Inyectores vacuno | 9 |
| Isperm | 26 |

J

| | |
|-------------------------------|-----|
| Jabón laboratorio PH | 75 |
| Jarra plástico | 31 |
| Jeringa Bovivet | 100 |
| Jeringa Dermojet | 93 |
| Jeringa desechable | 99 |
| Jeringa dosificadora | 92 |
| Jeringa multidosis IA conejos | 19 |
| Jeringa Socorex | 96 |
| Jeringa tuberculina | 97 |
| Juego números pintura | 113 |
| Junquillos | 41 |

K

| | |
|---------------------|-----|
| Kit completo visita | 104 |
| Kit inseminación | 7 |
| Kit necropsia | 88 |

L

| | |
|----------------------|-----|
| Lámpara IR | 138 |
| Lanceta | 132 |
| Lápiz descornar | 125 |
| Lápiz marcador | 113 |
| Lazo cerdos | 121 |
| Lector de microchips | 110 |
| Lector stick Allflex | 110 |

Índice de productos

| | |
|----------------------------|-----|
| Legra 70 cm estéril yegua | 13 |
| Legra hoja ancha | 128 |
| Legra hoja estrecha | 128 |
| Librador | 137 |
| Lima dental | 126 |
| Limpieza circuitos de agua | 148 |
| Lupa bicocular | 49 |
| Lupa trinocular | 49 |

M

| | |
|--------------------------------------|--------|
| Malla cabras | 145 |
| Malla ovejas | 145 |
| Mandil carnero | 114 |
| Mandrín para sonda | 14 |
| Mango bisturí | 89 |
| Mango madera rastrillo | 137 |
| Mango sirga | 90 |
| Mangos sirga descornar | 125 |
| Manguito desechable | 106 |
| Manguitos ordeño | 133 |
| Maniquí equino | 12 |
| Manta detección celos | 24 |
| Máquina envasadora semen porcino | 22 |
| Máquina para cascos | 128 |
| Maquinaria envasado en pajuelas | 34, 35 |
| Marca ovino colgar | 115 |
| Marca vacuno colgar | 115 |
| Marcaador spray | 113 |
| Marcas aves | 112 |
| Marcas Chevífix metal | 112 |
| Marcas Quick | 112 |
| Marcas Tip Tag | 112 |
| Martillo aluminio | 117 |
| Martillo para herrar | 129 |
| Mascarilla higiene | 106 |
| Mascarillas | 106 |
| Matraz aforado con tapón | 31 |
| Matraz Erlenmeyer | 31 |
| Maza para herrar | 129 |
| Medio de congelación embriones | 46 |
| Medio de descongelación de embriones | 46 |
| Medio de recogida embriones | 46 |
| Medio mantenimiento embrión | 46 |
| Metricheck | 91 |
| Microaspirador embriones | 47 |
| Microcélulas LEJA para sistema CASA | 27 |
| Microchip inyectable | 110 |
| Microdispensador embriones | 47 |
| MicroQ iQ1t | 49 |
| Microscopio µHandy | 27 |
| Microscopios | 28 |
| Mono azul | 104 |
| Mono de trabajo | 105 |
| Mono para partos | 105 |
| Mono ProShield | 104 |
| Mono Tyvex | 104 |
| Monitorización | 68-70 |
| Mosquetón | 121 |

N-O

| | |
|---------------------------|--------|
| Narigón | 119 |
| Nevera conservación semen | 21, 33 |
| Nevera de transporte | 10 |
| Nigrosina | 30 |
| Otoscopio | 73 |

P

| | |
|--|---------|
| Pajuela avícola | 16 |
| Pajuela Transferencia embriones estéril | 51 |
| Pajuelas | 40 |
| Pajuelas 0,50 ml | 19 |
| Pajuelas conejos | 18 |
| Pajuelas Transferencia de Embriones equino | 51 |
| Pala aluminio | 137 |
| Pala plástico | 137 |
| Paleta arreadora sonajero porcino | 118 |
| Pantalón partos | 105 |
| Paño campo absorbente | 86 |
| Papel indicativo mami | 132 |
| Papel parafilm | 75 |
| Parches de celo | 8 |
| Pasta descornar | 125 |
| Pastilla arnés | 114 |
| Pastores eléctricos | 142 |
| Pediluvio bovino | 128 |
| Pelvimetro novillas | 91, 135 |
| Pesador de calostro | 133 |
| Peto tirantes partos | 105 |
| PHmetro | 74 |
| Pienso para verracos | 147 |
| Pintura lana | 113 |
| Pinza Adson | 78 |
| Pinza anatómica | 78 |
| Pinza biopsia | 77 |
| Pinza Blendering | 77 |
| Pinza burdizo | 127 |
| Pinza compresora | 76 |
| Pinza cuello uterino | 77 |

| | |
|------------------------------------|-----|
| Pinza cuerpos extraños | 77 |
| Pinza disección | 78 |
| Pinza hemostática | 76 |
| Pinza intestinal Babcock | 76 |
| Pinza intestinal Doyen | 76 |
| Pinza Kocher | 76 |
| Pinza mosquito | 76 |
| Pinza para campo Backhaus | 76 |
| Pinza para campo Jones | 78 |
| Pinza para grapas | 82 |
| Pinza plástico pajuelas | 8 |
| Pinza presión útero laparoscopia | 11 |
| Pinza quirúrgica | 78 |
| Pinza Rochester | 76 |
| Pinza sujeta colas | 133 |
| Pinza sujetapatas | 131 |
| Pipeta cristal PASTEUR | 75 |
| Pipeta plástico PASTEUR | 75 |
| Pipetas | 30 |
| Pipetas cristal | 30 |
| Pipetas plástico | 30 |
| Piqueta toma tierra | 146 |
| Piquetas | 145 |
| Pistola sacrificio | 127 |
| Pistola Transferencia de Embriones | 50 |
| Placa calentable | 29 |
| Placa con mango | 41 |
| Placas con medio de cultivo | 74 |
| Placas estériles | 51 |
| Placas Petri estériles | 51 |
| Plataforma desmontable | 140 |
| Pluviómetro | 140 |
| Polvo sellador | 37 |
| Pooltester | 74 |
| Porta objetos | 29 |
| Porta-agujas | 80 |
| Portacebos | 141 |
| Potro de recogida cerdos | 20 |
| Precintos amarillos | 75 |
| Probeta graduada | 31 |
| Prolapso ovino | 135 |
| Prolapso para vacas | 135 |
| Protector halógeno | 138 |
| Protector hombro Kruuse | 105 |
| Protector inyector | 9 |
| Protector lámparas | 138 |
| Protector vainas | 9 |
| Pulsera plástico | 115 |
| Punta de inseminación DARIO | 10 |
| Punta Pipeta | 30 |

Q-R

| | |
|-----------------------------|-----|
| Quelutado de oligoelementos | 147 |
| Quitagrapas | 82 |
| Rampa de congelación | 39 |
| Rasqueta | 124 |
| Rastrillo curvo | 137 |
| Rastrillo recto | 137 |
| Reanimador terneros | 135 |
| Recambio cabezal | 122 |
| Recogedor | 146 |
| Refractómetro | 73 |
| Refractor | 138 |
| Registrador temperatura | 72 |
| Revólver Hauptner | 94 |
| Revólver plástico | 92 |
| Revólver Roux | 95 |
| Rotulador Allflex | 110 |

S

| | |
|--|--------|
| Sacabocados ovino | 114 |
| Secante de camas | 148 |
| Separador abdominal | 77 |
| Separador de Gelpi | 77 |
| Separador de leche | 132 |
| Separador Senn-Miller | 77 |
| Separador Weitlaner | 77 |
| Seripettor | 30 |
| Servicio de impresión de pajuelas | 36 |
| Sierra descornar eléctrica | 125 |
| Silla IA avícola | 17 |
| Sirga Bovivet | 90 |
| Sirga descornar Bovivet | 125 |
| Sistema de recogida embriones IMV 3 vías | 44 |
| Soldadura pajuelas embriones | 49 |
| Solución de tripsina | 46 |
| Sonda + guía Ovum Pick Up | 48 |
| Sonda Equivet embriones | 45 |
| Sonda esofágica | 134 |
| Sonda espuma | 24, 25 |
| Sonda espuma intrauterina | 24, 25 |
| Sonda estéril IA equino sin jeringa | 14 |
| Sonda estéril inseminación profunda | 14 |
| Sonda estéril recolección embrión | 44 |
| Sonda intrauterina espiral | 25 |
| Sonda Osiris | 19 |
| Sonda tipo Foley embriones | 45 |
| Sonda tipo Luer embriones | 45 |

| | |
|-----------------------------|--------|
| Sondas electro-eyaculadores | 5 |
| Sondas nasoesofágicas | 134 |
| Soporte cascos | 129 |
| Soporte pipetas | 30 |
| Suela pástico Easy Bloc | 131 |
| Sulfatadoras | 141 |
| Suturas absorbibles | 83, 84 |
| Suturas no absorbibles | 85 |

T

| | |
|--------------------------------------|----------|
| Taco madera DEMOTEC | 131 |
| Tampón tinta martillo | 117 |
| Tanque nitrógeno presurizado | 38 |
| Tanques nitrógeno bajo consumo | 42 |
| Tanques nitrógeno en seco | 42 |
| Tanques nitrógeno gran capacidad | 42 |
| Tatuadores | 116 |
| Tenaza grapa cerdos | 120 |
| Tenaza lateral cascos | 129 |
| Tenaza marcas Quick | 112 |
| Tenaza marcas Tip Tag | 112 |
| Tenaza para anillas toro | 120 |
| Tenaza para herrar | 129 |
| Tenazas gomas descolar | 126 |
| Tenazas marcas Allflex | 110 |
| Tensor cinta | 146 |
| Termo recogida | 20 |
| Termómetro ambiente | 140 |
| Termómetro digital | 72 |
| Termómetro digital con sonda | 72 |
| Termómetro infrarrojos | 72 |
| Termómetro líquidos | 72 |
| Termómetro para leche | 133 |
| Tester pastor eléctrico | 146 |
| Tetina ovino | 136 |
| Tetina vacuno | 136 |
| Tijera curva | 79 |
| Tijera dentada | 79 |
| Tijera disección | 79 |
| Tijera Iris | 79 |
| Tijera lana | 124 |
| Tijera Lister | 78 |
| Tijera marcar | 114, 124 |
| Tijera Mayo | 79 |
| Tijera recta | 79 |
| Tijera sutura | 79 |
| Tijera universal | 78 |
| Tinta alimentaria | 117 |
| Tinta bola | 116 |
| Tinta negra | 117 |
| Tinta pasta | 116 |
| Tira acetona | 74 |
| Tira orina | 74 |
| Tira reactiva Peróxido | 74 |
| Tira reactiva PH | 74 |
| Toallitas desinfección | 24 |
| Toallitas desinfección pezones | 133 |
| Traba correctora | 118 |
| Traba evitacoces | 133 |
| Trabón para patas | 118 |
| Traje de lluvia | 105 |
| Trampa ratones curva | 141 |
| Transcap ovino con guía | 11 |
| Tratamiento de trastornos digestivos | 147 |
| Trocar | 134 |
| Trocar inseminación ovino | 11 |
| Tubo centrífuga | 32 |
| Tubo colector ovino | 10 |
| Tubo colector para OPU | 48 |
| Tubo colector semen | 6 |
| Tubo en Y Agtech embriones | 45 |
| Tubo Eppendorf | 32 |
| Tubo extracción sangre | 72 |
| Tubo recolección semen aviar | 16 |
| Tubo recolecta conejos | 18 |

V

| | |
|--|---------|
| Vacunadores | 98 |
| Vagina artificial bovino | 6 |
| Vagina artificial equino | 13 |
| Vagina artificial ovino/caprino/canino | 10 |
| Vagina artificial conejos | 18 |
| Vaina ovino | 11 |
| Vaina para pistola embriones | 50 |
| Vaina universal Alpha | 9 |
| Vaina universal hendida | 9 |
| Vaso de precipitado | 31 |
| Vaso desinfección pezones | 133 |
| Venda alquitrán | 130 |
| Venda de gasa | 87 |
| Venda Soft-Flex | 130 |
| Venda Vet-Plast | 130 |
| Vendaje ubres | 132 |
| Vendas de yeso | 87, 130 |
| Verrachoc | 21 |
| Visotubo | 41 |

Condiciones de venta

- Salvo indicación en sentido contrario por parte del cliente, el material será enviado por el transporte que Consorcio Mercantil de Huesca, S.L. (HUMECO) designe. Para compras inferiores a 300€, los gastos de envío serán a cargo del cliente.
- Para realizar cualquier reclamación sobre el envío hay un plazo máximo de 48 horas desde la recepción de la mercancía por parte del cliente. Consorcio Mercantil de Huesca, S.L. (HUMECO), se compromete a la reposición del material defectuoso una vez comprobado y aceptado por nuestro personal.
- El hecho de la recepción de la mercancía por parte del comprador supone que este la ha examinado y la encuentra conforme.
- Consorcio Mercantil de Huesca, S.L. (HUMECO), no se hace responsable de las posibles lesiones, pérdidas o daños derivados de un mal uso de los productos.
- Los envíos contra-reembolso tendrán un 3% de descuento por pronto pago.
- Las compras inferiores a 300€ se girarán a la vista.
- Consorcio Mercantil de Huesca, S.L. (HUMECO), se reserva el derecho de anular, modificar total o parcialmente este catálogo, sus precios y la supresión de cualquiera de los artículos sin previo aviso, no haciéndose responsable de los daños que de ello se pudieran ocasionar.
- Consorcio Mercantil de Huesca, S.L. (HUMECO), se reserva el derecho de cancelar total o parcialmente un pedido, como consecuencia del incumplimiento de las condiciones de venta establecidas.



Humeco
Productos veterinarios



Consortio Mercantil de Huesca, S.L.
Pol. Sepes. C/ De la Mecánica 11
22006 Huesca

974 231 165
humeco@humeco.net
www.humeco.net

www.humeco.net